

U H
500
9U578t
1941

WAR DEPT FM 8-35

WAR DEPARTMENT

MEDICAL FIELD MANUAL

TRANSPORTATION OF
THE SICK AND WOUNDED

February 21, 1941



~~Box 1248~~

NATIONAL LIBRARY OF MEDICINE



NLM 00076533 6

**U.S. NATIONAL
LIBRARY
OF
MEDICINE**

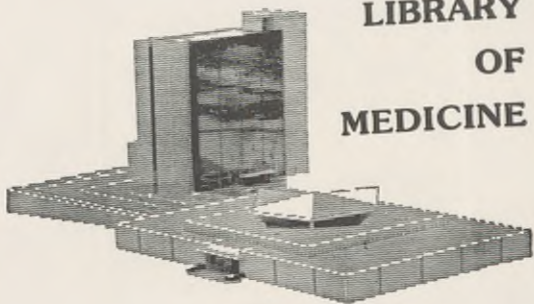

RETURN TO
NATIONAL LIBRARY OF MEDICINE
BEFORE LAST DATE SHOWN

2
JAN 26 1989

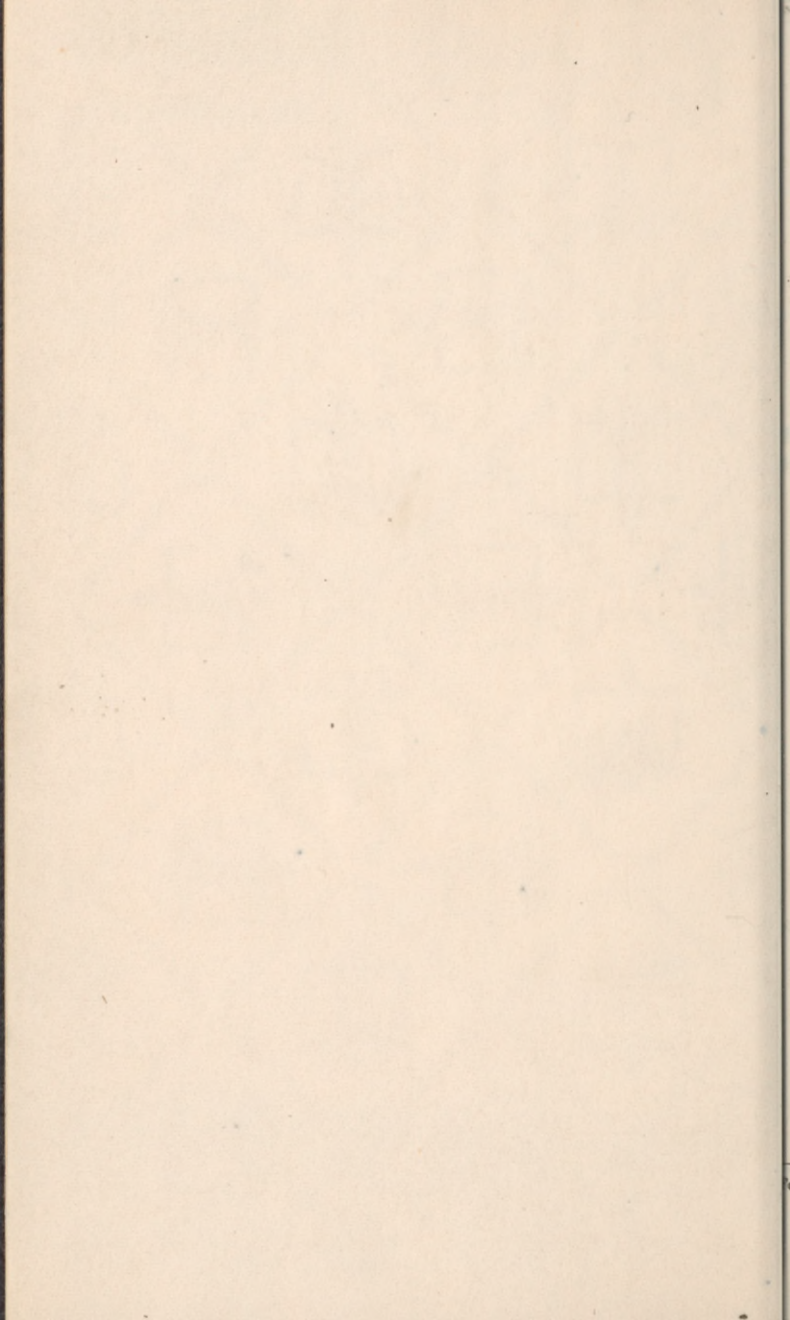

Surgeon General's Office

FM 8-35

MEDICAL FIELD MANUAL

TRANSPORTATION OF THE SICK AND WOUNDED

Prepared under the direction of
The Surgeon General

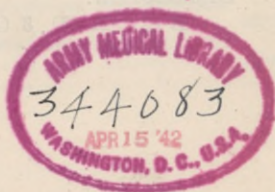

UNITED STATES
GOVERNMENT PRINTING OFFICE
WASHINGTON : 1941

WH
500
8 U578t
1941
c.1

WAR DEPARTMENT,
WASHINGTON, February 21, 1941.

FM 8-35, Medical Field Manual, Transportation of the Sick and Wounded, is published for the information and guidance of all concerned.

[A. G. 062.11 (10-30-40.)]

BY ORDER OF THE SECRETARY OF WAR:

G. C. MARSHALL,
Chief of Staff.

OFFICIAL:

E. S. ADAMS,
*Major General,
The Adjutant General.*

DISTRIBUTION:

B (2); R (2), 8 (10); Bn 8 (5); C 8 (10).



UNITED STATES
GOVERNMENT PRINTING OFFICE
WASHINGTON : 1941

MEDICAL FIELD MANUAL

TRANSPORTATION OF THE SICK AND WOUNDED

TABLE OF CONTENTS

	Paragraphs	Page
CHAPTER 1. GENERAL -----	1-5	1
CHAPTER 2. MANUAL TRANSPORT FOR SICK AND WOUNDED.		
Section I. General -----	6-8	2
II. Instruction in manual transport--	9-12	27
CHAPTER 3. LITTER TRANSPORTATION OF THE SICK AND WOUNDED.		
Section I. General -----	13-17	36
II. Instruction in the use of the litter-----	18-24	45
CHAPTER 4. ADJUNCTS TO THE LITTER IN THE TRANSPORTATION OF THE SICK AND WOUNDED.		
Section I. General -----	25-28	98
II. Instruction in the use of the wheeled litter carrier-----	29-31	110
CHAPTER 5. AMBULANCE TRANSPORTATION OF THE SICK AND WOUNDED.		
Section I. General -----	32-36	118
II. Instruction in ambulance loading and unloading-----	37-41	131
CHAPTER 6. AIR TRANSPORTATION OF THE SICK AND WOUNDED-----	42-48	137
CHAPTER 7. RAIL TRANSPORTATION OF THE SICK AND WOUNDED-----	49-54	147
CHAPTER 8. WATER TRANSPORTATION OF THE SICK AND WOUNDED-----	55-60	161
INDEX -----		169

MEDICAL FIELD MANUAL

TRANSPORTATION OF THE SICK AND WOUNDED

(This manual supersedes TR 405-50, October 7, 1924; TR 405-60, May 10, 1927; TR 405-80, October 7, 1924; and TR 405-90, March 29, 1926.)

CHAPTER 1

GENERAL

■ 1. PURPOSE OF MANUAL.—The purpose of this manual is to describe methods and means by which patients may be transported in the field.

■ 2. SCOPE OF MANUAL.—This manual includes a brief description of all common methods of transporting patients by land, sea, and air; means of transport, ranging from the hand litter to the hospital ship; and methods of instructing personnel in the employment of such methods and means.

■ 3. RELATION OF TRANSPORTATION TO MEDICAL TASK.—One of the chief responsibilities of the medical service is the evacuation of sick and wounded. Prompt and orderly evacuation of casualties from forward areas, in a manner calculated least to interfere with other military requirements, allows combat units to preserve their mobility and promotes the morale of the remaining effectives (FM 8-10). Evacuation must be continuous; it must be carried out with all speed possible without endangering life or limb and, in modern warfare, under many serious handicaps. Evacuation includes the collection of casualties on the battlefield and their subsequent movement through every medical installation from aid station to general hospital. The transport involved in this movement must be designed to meet the particular conditions existing in various stages of the journey.

■ 4. PRINCIPLES OF EVACUATION.—See FM 8-10.

■ 5. RESPONSIBILITY FOR EVACUATION.—See FM 8-10.

CHAPTER 2

MANUAL TRANSPORT FOR SICK AND WOUNDED

	Paragraphs
SECTION I. General.....	6-8
II. Instruction in manual transport.....	9-12

SECTION I

GENERAL

■ 6. GENERAL.—Not infrequently situations arise demanding the movement of patients without litters or other equipment. Such situations may require that the patient be lifted and carried by hand, by one or more bearers. In the selection of a method for such movement, two factors must be considered:

a. Nature of disability and the care necessary to preclude complications likely to arise as a result of movement.

b. Element of fatigue of bearer which indicates that the method be least awkward and tiring, especially when the carry involves any appreciable distance.

■ 7. MOVEMENT BY ONE BEARER.—a. *Supporting carry*.—When patients are conscious and the character of their disabilities permits, they may be assisted in walking. This assistance is designated the "supporting carry." The procedure is as follows:

(1) The bearer turns the patient on his face (fig. 1) and steps astride the patient's body, facing his head (fig. 2).

(2) The bearer places his hands under the patient's armpits and raises him to his knees (fig. 3).

(3) The bearer clasps the patient around his waist and raises him to his feet (fig. 4).

(4) The bearer seizes the patient's left wrist with his left hand and draws the patient's left arm around the bearer's neck (fig. 5). The patient's body now rests against the right side of the bearer's body, the latter's arm being placed around the patient's waist for support (fig. 6).

(5) The patient walks, assisted by the bearer.

b. Arms carry.—This method is applicable to an unconscious as well as to a conscious patient. The procedure is as follows:

(1) The patient is brought to upright position by the first three steps described in the supporting carry (*a* above).

(2) The bearer turns slightly toward his right (left), brings his right arm upward to a supporting position about the patient's back, and passes his left (right) arm under the patient's thighs (fig. 7).

(3) The bearer lifts the patient into a carrying position. The patient should be carried high to lessen fatigue (fig. 8).



FIGURE 1.—Supporting carry, first step.

c. Saddle-back carry.—This method cannot be employed except with the cooperation of the patient. The procedure is as follows:

(1) The patient is brought to upright position by the first three steps described in the supporting carry (*a* above).

(2) The bearer maintains a pull on the patient's arm (fig. 9) and steps in front of the patient. Then, with his back to him, bearer stoops and raises the patient upon his back (fig. 10). The patient having encircled the bearer's neck with his arms, the bearer grasps the patient's thighs (fig. 11).

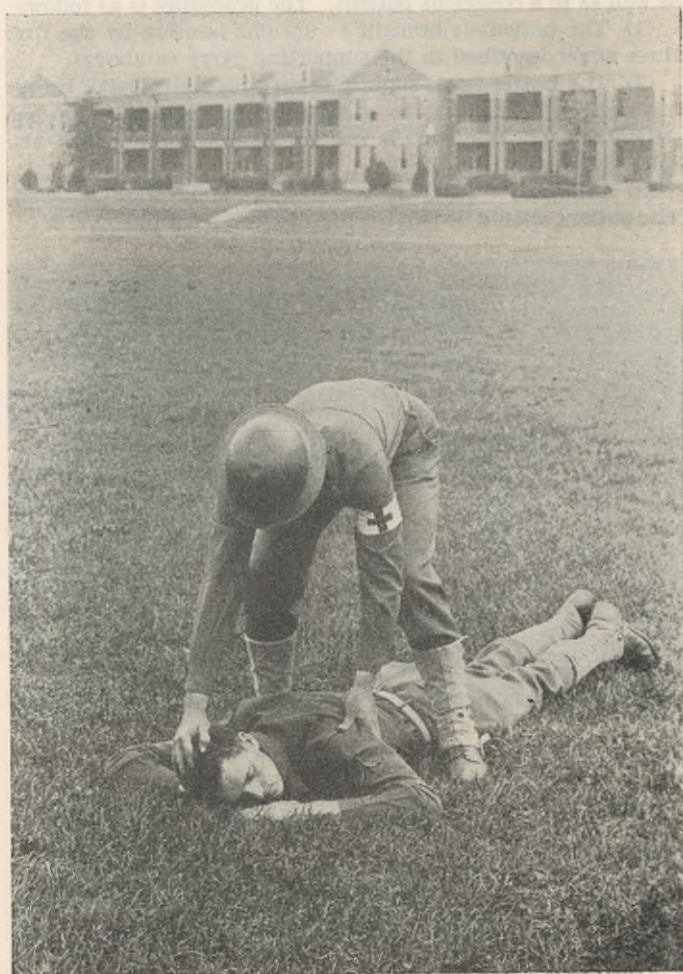

FIGURE 2.—Supporting carry, second step.

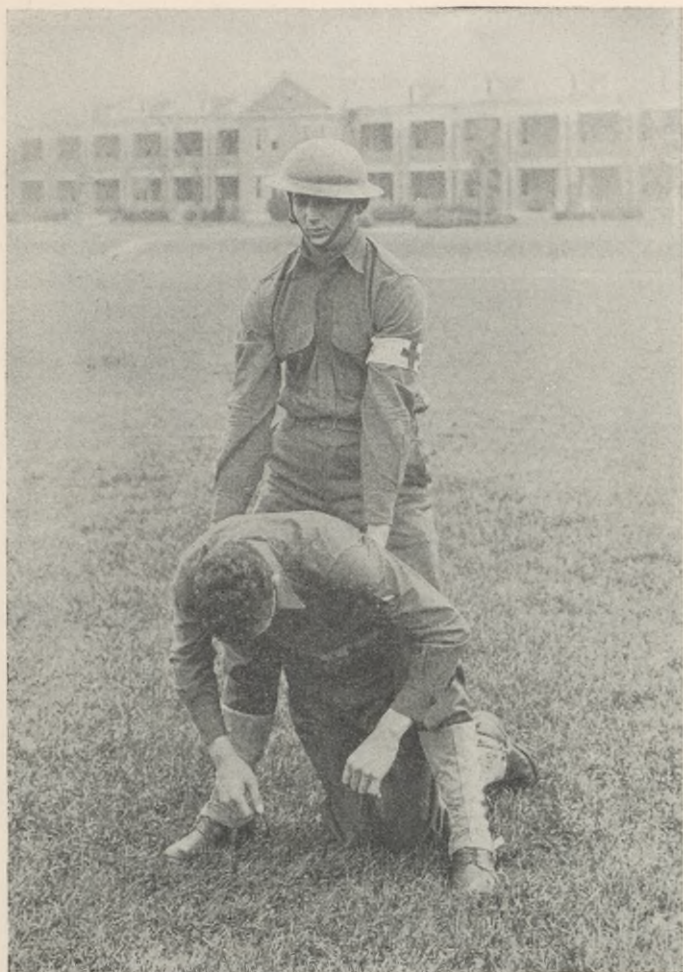

FIGURE 3.—Supporting carry, third step.



FIGURE 4.—Supporting carry, fourth step.



FIGURE 5.—Supporting carry, fifth step



FIGURE 6.—Supporting carry.



FIGURE 7.—Arms carry, fourth step.



FIGURE 8.—Arms carry.



FIGURE 9.—Saddle-back carry, fourth step.



FIGURE 10.—Saddle-back carry, fifth step.



FIGURE 11.—Saddle-back carry, sixth step.



FIGURE 12.—Saddle-back carry.

(3) The bearer resumes upright position, at the same time lifting the patient, bringing him well up on his back. The patient continues to secure himself by grasping the bearer's neck (fig. 12).

d. Fireman's carry.—This is the method of preference in the movement of an unconscious patient. The procedure is as follows:

(1) The patient is brought to upright position by the first three steps described in the supporting carry (*a* above).

(2) The bearer passes around to face the patient's left, grasps the patient's right wrist with his left hand, and pulls upward (fig. 13).

(3) The bearer stoops (fig. 14), passes his right arm between the patient's legs, and then draws the patient over his left shoulder (fig. 15).

(4) The bearer passes the patient's right wrist to his own right hand (fig. 16), reaches backward with his left hand and grasps the patient's left wrist, and draws the patient's left arm forward and around the bearer's body (fig. 17).

(5) The bearer then resumes upright position (fig. 18).

■ 8. MOVEMENT BY TWO BEARERS.—*a. Supporting carry.*—By this method, two bearers, one on each side, assist a conscious patient in walking. The procedure is similar to that described in paragraph 7*a* (see fig. 6).

b. Arms carry.—This method is applicable to patients, conscious or unconscious, requiring movement for a limited distance, or when being loaded on some mechanical carrier. The procedure is as follows:

(1) With the patient lying on his back, the bearers kneel on one knee, on the same side of the patient, and place their arms beneath the patient as follows:

(*a*) One bearer places an arm beneath the patient's shoulders, the partially bent elbow supporting the head and neck, the other arm beneath the patient's back at about the lower rib margins.

(*b*) The other bearer places his arms beneath the patient's hips and knees, respectively (fig. 19).

(2) Bearers lift patient to their knees (fig. 20).



FIGURE 13.—Fireman's carry, fourth step.



FIGURE 14.—Fireman's carry, fifth step.



FIGURE 15.—Fireman's carry, sixth step.



FIGURE 16.—Fireman's carry, seventh step.

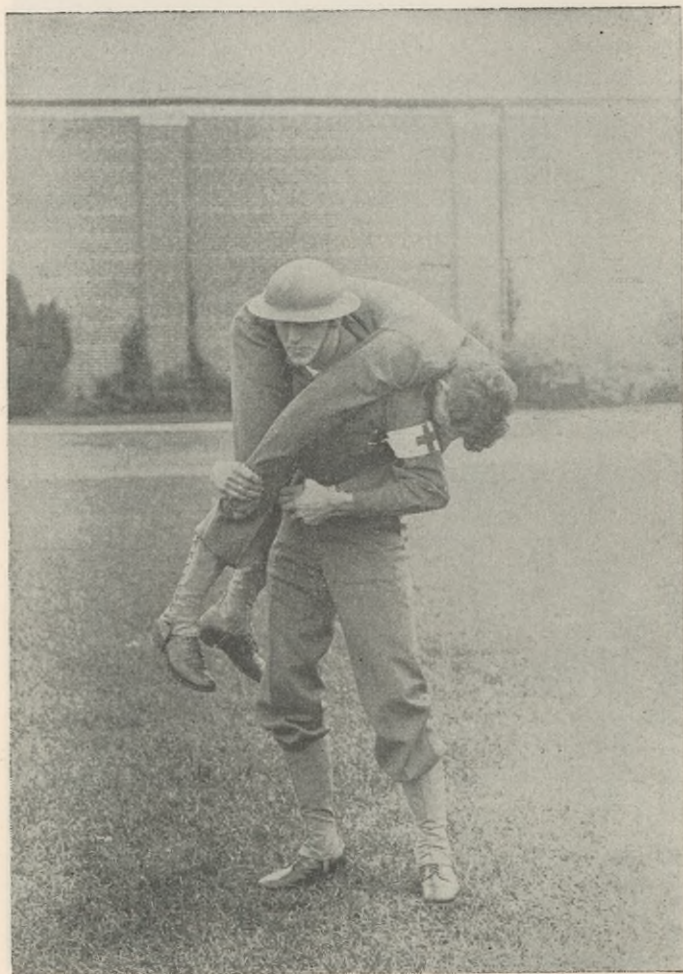

FIGURE 17.—Fireman's carry, eighth step.



FIGURE 18.—Fireman's carry.



FIGURE 19.—Arms carry, beginning (2 bearers).



FIGURE 20.—Arms carry, second step (2 bearers).

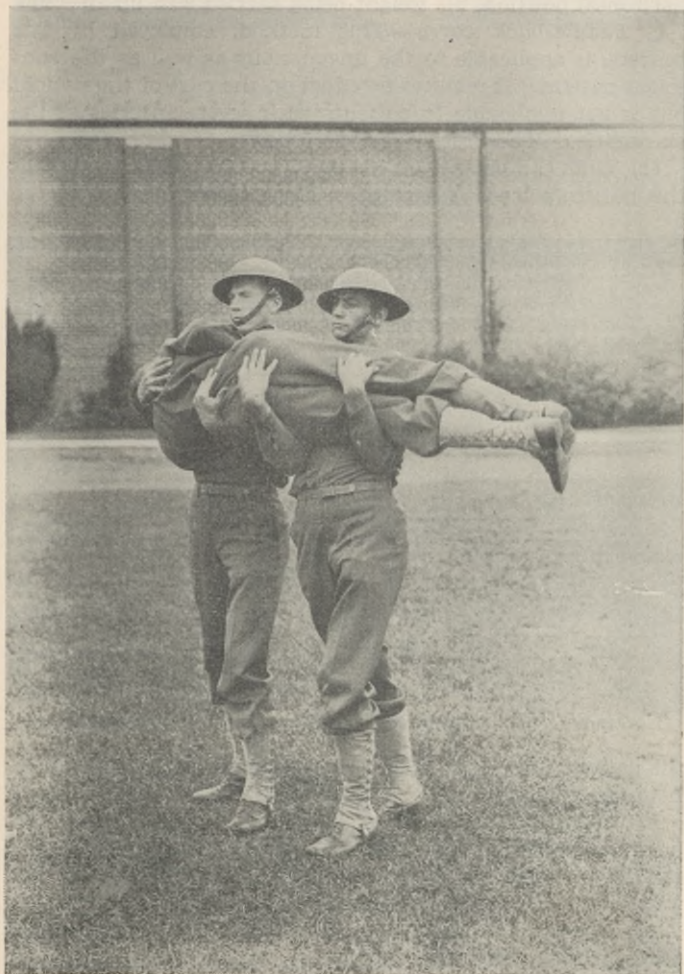

FIGURE 21.—Arms carry (2 bearers).

(3) Bearers rise simultaneously, lifting the patient in horizontal position, his weight being carried well up (fig. 21).

c. *Saddle-back carry*.—This method, employed by two bearers, is applicable to the unconscious as well as the conscious patient. It requires no effort on the part of the patient but is not applicable to patients with severe injuries of the extremities. The procedure is as follows:

(1) With the patient on his back, the front bearer spreads the patient's lower extremities, steps between them facing



FIGURE 22.—Saddle-back carry, beginning (2 bearers).

the patient's feet, kneels, and grasps the patient's thighs with his arms (fig. 22).

(2) At the same time, the rear bearer kneels at the patient's head facing the patient, thrusts his arms beneath the patient's shoulders, brings his forearms inside the patient's arms, upward and across the patient's chest (fig. 23).

(3) Bearers rise simultaneously, lifting the patient into a semirecumbent position (fig. 24).

d. *Packsaddle carry*.—This method is applicable only to a conscious patient. The procedure is as follows:



FIGURE 23.—Saddle-back carry, actions rear bearer.



FIGURE 24.—Saddle-back carry, completed (2 bearers).



FIGURE 25.—Packsaddle carry, first step.

(1) The bearers face each other, each grasping his left wrist with his own right hand (figs. 25 and 26).

(2) A seat is then made by interlacing the four hands, each bearer grasping the other's right wrist with his own free left hand (figs. 27 and 28).

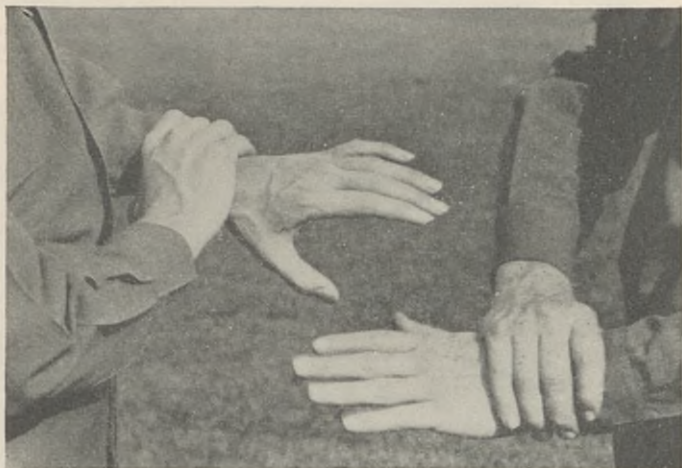

FIGURE 26.—Packsaddle carry (close-up).

(3) On this improvised seat the patient sits, supporting himself by placing an arm around the neck of each bearer (figs. 29 and 30).

SECTION II

INSTRUCTION IN MANUAL TRANSPORT

■ 9. GENERAL—*a. Purpose.*—The purpose of this section is to provide guides for instruction in the manual transport of patients, thus insuring uniformity in the application of proper procedures and the saving of valuable training time. It is in no sense a drill, and the commands are for instruction purposes only.

b. Formation for instruction.—(1) For instruction in the handling of a patient by one bearer, the unit will be formed



FIGURE 27.—Packsaddle, completed.

in two ranks, facing each other. After each rank has counted off, men with the same number form teams, the two ranks alternating in the role of patient and bearer.

(2) For instruction in 2-bearer transport, formation will be in single rank, the unit then being divided into groups of threes. The individual members of each group will be alternated in the roles of No. 1 bearer, No. 2 bearer, and patient. The No. 1 bearer will be in charge of each group.



FIGURE 28.—Packsaddle, completed (close-up).

c. Demonstration.—The speed and value of this instruction will be enhanced by utilization of the applicatory system, that is, demonstration followed by practice.

d. Commands.—The following types of commands are utilized in instruction: preparatory commands and commands of execution. The former are distinguished by appearing in small capitals, the latter in large capitals.

■ 10. TO CARRY PATIENT BY ONE BEARER (see par. 7).—Instruction is carried out by means of a single set of commands varied to meet the requirements of each method of handling the patient.



FIGURE 29.—Placing patient on packsaddle.

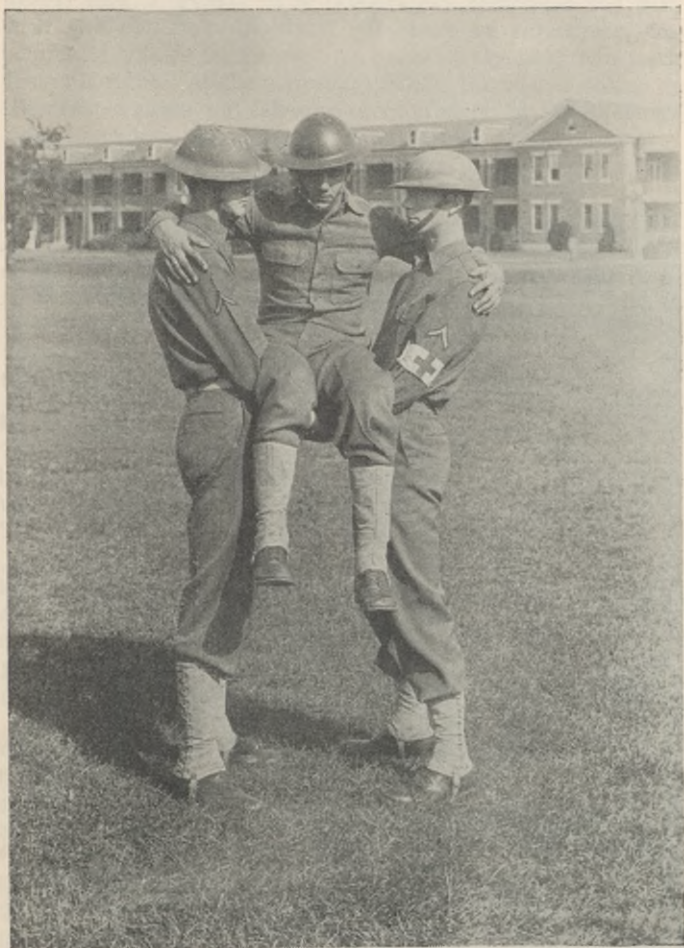

FIGURE 30.—Carrying patient on packsaddle.



FIGURE 31.—One bearer, RIGHT (LEFT) SIDE, POST.

a. To place bearer in position.—The patient being prone, to place the bearer in position, the commands are: 1. RIGHT (LEFT) SIDE, 2. POST. The preparatory command will vary with the patient's disability. If there be no choice, the command will be LEFT SIDE, thus enabling the bearer to work from his right. At the command POST, the bearer moves by the nearest route and takes an erect position by the patient's right (left) hip, facing the patient (fig. 31).

b. To lift patient.—The bearer being in position, to lift the patient to the carry, the commands are: 1. BY SUPPORTING CARRY (or other type carry desired), 2. LIFT, 3. PATIENT. At the first command, the bearer stands fast. A short pause after this command enables the bearer to mentally review the actions he will take. At the second command, the bearer proceeds to bring the patient to an erect position (see par. 7a). At the command PATIENT, the bearer lifts the patient to the position indicated by the first command.

■ 11. TO CARRY PATIENT BY TWO BEARERS (see par. 8).—*a. To place bearers in position.*—As in the case of the single bearer carry, to place bearers in position, the same commands, varied to meet the desired method of carry, are prescribed. These commands are as follows:

(1) *Supporting carry.*—To place bearers in position for the supporting carry, the commands are: 1. BOTH SIDES, 2. POSTS. At the command POSTS, bearers proceed by the most direct route to the patient and take erect positions facing the patient, No. 1 opposite the right, and No. 2 opposite the patient's left hip (fig. 32).

(2) *Arms carry.*—To place bearers in position for the arms carry, the commands are: 1. RIGHT (LEFT) SIDE, 2. POSTS. At the command POSTS, bearers take position on the right (left) side of the patient, No. 1 opposite and facing the patient's hip, No. 2, the patient's shoulder (fig. 33).

(3) *Saddle-back carry.*—To place bearers in position for the saddle-back carry, the commands are: 1. HEAD AND FEET, 2. POSTS. At the command POSTS, bearers take position as follows: No. 1 between the patient's legs, No. 2 at the patient's head, both facing the patient's feet (fig. 34).



FIGURE 32.—Two bearers, BOTH SIDES, POSTS.



FIGURE 33.—Two bearers, RIGHT (LEFT) SIDE, POSTS.

b. To lift patient.—The bearers being in position, to lift patient, the commands are: 1. BY SADDLE-PACK CARRY, (or other type carry desired), 2. LIFT, 3. PATIENT. At the second command, bearers place themselves and the patient in the necessary position for lifting. At the command PATIENT, bearers lift patient to the position designated in the first command.



FIGURE 34.—Two bearers, HEAD AND FEET, POSTS.

■ 12. TO LOWER PATIENT.—Whether one or two bearers are being utilized, to lower patient, the commands are : 1. LOWER, 2. PATIENT. At the command PATIENT, patient is carefully lowered to a prone position by a reversal of the steps by which he was originally lifted, when the bearer or bearers resume posts assumed prior to lifting the patient.

CHAPTER 3

LITTER TRANSPORTATION OF THE SICK AND WOUNDED

	Paragraphs
SECTION I. General.....	13-17
II. Instruction in the use of the litter.....	18-24

SECTION I

GENERAL

■ 13. GENERAL.—*a. Litter, definition.*—A litter is a stretcher, carried by two or more bearers, for the movement of sick and wounded.

b. Classification of cases.—(1) *Ambulant.*—All sick and wounded patients who are able to walk from the place where they become casualties to the medical installation designed for their treatment, without aggravating their condition, are classified as ambulant or ambulatory cases.

(2) *Litter.*—All patients who are unable to walk either with or without assistance, or whose condition might be aggravated by walking, are classified as litter cases. All litter cases, regardless of whether they occur in posts, camps, or on the battlefield, will require more or less movement on a litter, or on a substitute therefor. The distance of movement by litter and the terrain over which movement will be accomplished will vary with the situation.

c. Requisites of military litter.—For satisfactory employment in the military service, a litter must possess the following requirements:

(1) *Size.*—The size of the litter must be sufficient to accommodate individuals whose height and weight are within the maximum limits as prescribed by the War Department, without undue discomfort.

(2) *Weight.*—The weight should be as light as possible without sacrificing necessary strength and durability.

(3) *Durability.*—The durability should be commensurate with the rough usage entailed in prolonged field operations.

(4) *Type*.—It should be collapsible in at least one axis to facilitate handling, storage, and movement to the point of employment.

(5) *Standardization*.—All litters should possess the same dimensions when open. This allows a patient to pass through the various echelons of medical service, entailing movement on several types of carrier, without being removed from the litter upon which he initiates his journey. The benefits thus derived are twofold: first, loss of valuable time is precluded; and second, danger to the patient incident to changing litters is obviated. This standardization is highly desirable not only throughout the military service but also between the military and naval services to facilitate evacuation during joint operations. (See FM 8-25.)

■ 14. LITTERS EMPLOYED BY THE MEDICAL DEPARTMENT.—*a. Litter, canvas, aluminum pole* (fig. 35).—The standard Medical Department nonfolding litter is the aluminum pole type, so-called to distinguish it from the former standard wooden pole litter, many of which are still in service and will continue to be employed until they reach a state of unserviceability. Both the aluminum and the wooden pole litters are further designated nonfolding to distinguish them from the folding litter, although actually they are capable of being folded in one axis with consequent approximation of the poles. The aluminum pole litter consists of a canvas bed, 6 feet long and 22½ inches wide, supported by two aluminum alloy poles which are inserted into heavily-stitched casings on either side of the canvas. The poles are tubular, 1.54 inches in diameter and 77 inches long, and equipped at either end with knurled wooden handles which project 6½ inches beyond the pole ends. Each pole is supported (when the litter is grounded) by two feet or stirrups, 3¾ inches wide and 5¼ inches high, bolted firmly to the pole, 18½ inches from the outer end of the handle. These bolts perform the dual role of securing the stirrup and preventing the canvas from slipping on the pole. Conversely, removal of the stirrup bolts allows replacement of worn canvas. Straight, single-jointed spreader bars extending crosswise between adjacent stirrups hold the canvas taut. The litter weighs approximately 15

pounds and, when collapsed, occupies a comparatively small space. All parts of the litter are of aluminum alloy except the canvas bed, wooden handles, and cadmium-plated steel stirrup bolts. There are no slings attached to the aluminum pole litter. Two web litter-carrying straps are included in the individual equipment of the Medical Department soldier. These straps are attached by snaps to the forward and rear rings on the suspender, the length adjusted by means of sliding loops, and the handles of the litter inserted into the slings

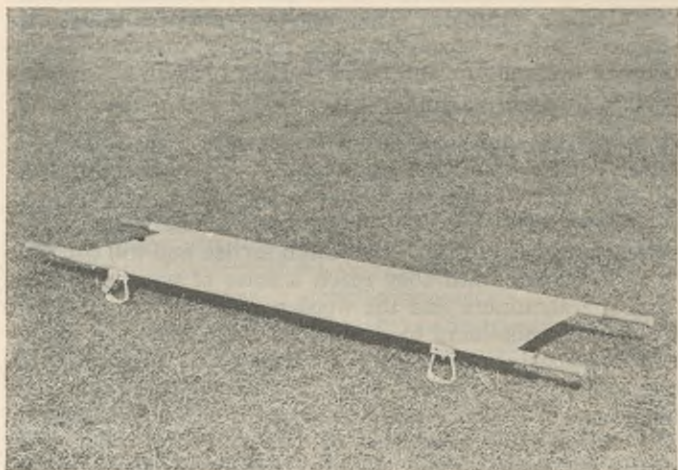

FIGURE 35.—Aluminum pole litter (open).

thus formed. The aluminum pole litter possesses the following distinct advantages over earlier types: considerably less weight and greater durability.

b. Litter, canvas, wooden pole (fig. 36).—The wooden pole litter consists of a canvas bed 6 feet long and 22 inches wide, made fast to two wooden poles $7\frac{1}{2}$ feet long, and made taut by two jointed spreader bars. The stirrups, 4 inches high and $1\frac{3}{4}$ inches wide, are similar to those of the aluminum pole litter. On the left front and right rear handles, a half-round iron ring is fixed $4\frac{1}{2}$ inches from the end, and between this and the canvas plays the movable ring of the litter sling.

One pair of slings is permanently attached to the litter. The slings are of khaki-colored webbing, $2\frac{1}{2}$ inches wide, with a leather-lined loop or bight at each end, and each sling is equipped with a metal slide to regulate the length. One loop of the sling passes through a metal swivel, itself attached to the movable ring of the handle. The weight of this litter is approximately 22 pounds.

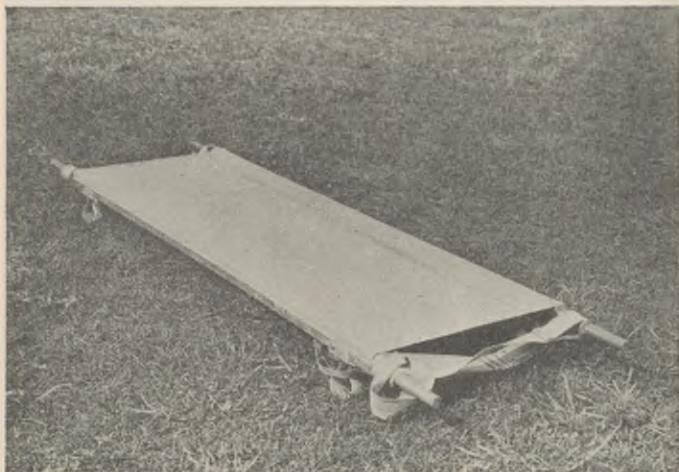

FIGURE 36.—Wooden pole litter (open).

c. Litter, canvas, folding (fig. 37).—The standard folding litter is similar to the aluminum pole litter, except that it not only collapses in its long axis but also folds at the center, a characteristic made possible by a socket-type joint near the middle of each pole. The weight of this litter is approximately $15\frac{1}{2}$ pounds. Originally designed to permit carrying with the top load on a pack saddle, it also lends itself to storage in airplane and other compartments of limited dimensions.

d. Litter, metal, airplane (figs. 38 and 39).—The metal basket, modified Stokes, litter is no longer a standard item, although it is still used to a limited extent by the attached medical personnel with the Air Corps. It is approximately 7 feet long, 23 inches wide, 8 inches deep, and weighs about

20 pounds. The litter consists of a rigid frame of steel tubing, to which wire mesh netting is attached to form a bed. The lower half is divided to form two compartments conforming, in general, to the lower extremities of the patient. Its chief advantage lies in the security of the patient when the litter is tilted. The Navy uses this general type of litter, especially for loading patients from small boats to large hospital ships or transports. For mass evacuation by air, employment of the standard litter is deemed preferable. (See ch. 6.)

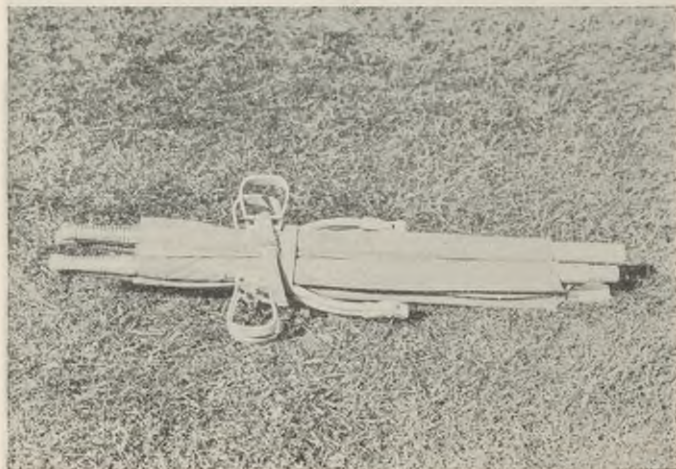

FIGURE 37.—Folding litter (closed).

■ 15. IMPROVISATION OF LITTERS.—In the absence of actual litters, satisfactory substitutes may be improvised, the product varying with the material at hand and the ingenuity of the individual or individuals concerned. The following improvisations are suggested, not only for their own merit but also as models on which to base other satisfactory substitutes.

a. Improvised rifle litter.—(1) *With rifles and overcoat.*—The barrel of a rifle is inserted through each sleeve of an overcoat turned inside out and buttoned, sleeves inside, buttons down, collar toward the rifle butts. The front bearer rolls the tail of the overcoat tightly around the barrels

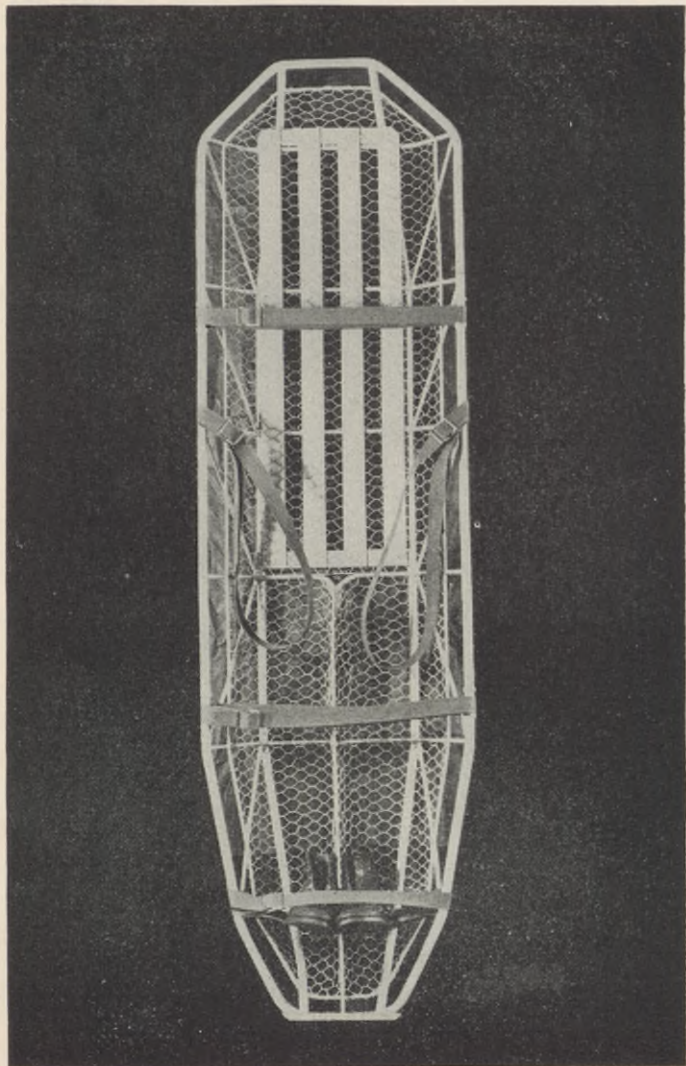

FIGURE 38.—Modified Stokes litter (empty).



FIGURE 39.—Modified Stokes litter, with patient.

and takes his grasp over them; the rear bearer holds by the butts, trigger guards up.

(2) *With rifles and blanket.*—A blanket being folded once from side to side, a rifle is laid transversely upon it across its center so that the butt and muzzle project beyond the edges; one end of the blanket is folded upon the other and a second rifle laid upon the new center in the same manner as before. The free ends of the blanket are now folded upon the end containing the first rifle so as to project a couple of inches beyond the first rifle. This is carried in a manner similar to that described in (1) above.

(3) *With rifles and blouses.*—Two or three blouses may be utilized in the same manner as, and in lieu of, the overcoat described in (1) above.

b. Improvised pole litters.—(1) *With poles and blanket* (fig. 40).—A most satisfactory litter may be improvised by utilizing a blanket and two poles approximately 7 feet in length. The blanket is spread lengthwise on the ground. One pole is laid across the center of the blanket which is then folded over it. The second pole is placed across the center of the new fold and the blanket is folded over the second pole as over the first. Another method of utilizing the same means consists of rolling one-half of the blanket into a cylinder which is placed alongside the back of the patient who has been carefully turned on his side; the patient is then turned over upon the blanket and the cylinder unrolled on the other side. The poles are then laid down on the outer edges of the blanket and rolled tightly toward the patient, each a like number of times, until the side of the patient has been reached.

(2) *With poles and blouses or overcoats* (fig. 41.)—Two poles and two overcoats, or three blouses, may be utilized in the following manner: sleeves reversed, coats buttoned, and poles passed through the sleeves in such manner as to place the buttons of the garments beneath the litter bed. The position of the collars, that is, front or back, is immaterial.

(3) *With poles and shelter half.*—The shelter half may be utilized in the same manner as described for the blanket in (1) above.

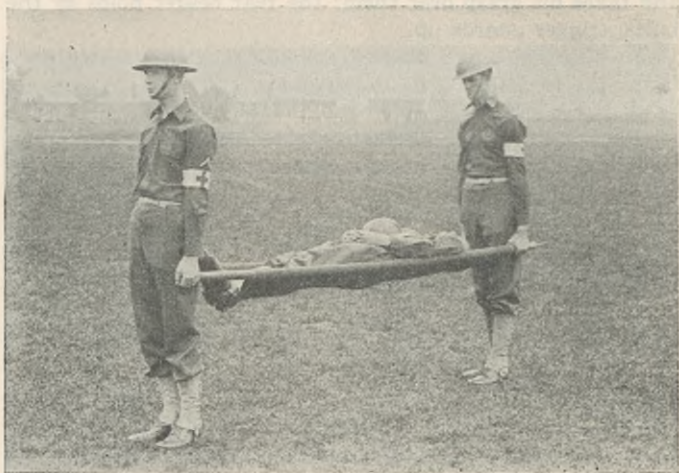

FIGURE 40.—Improved litter, poles and blanket.



FIGURE 41.—Improved litter, poles and overcoat.

(4) *With miscellaneous items.*—With poles as a basis, various other items may be utilized in the improvisation of litters, for example, cloth sacks or bags, bedticks, matting, rugs, carpets, woven rope or rawhide strips, and other similar items.

c. Utilization of litter-shaped objects.—Many common items, such as properly padded camp cots, doors, benches, and ladders, may be utilized as improvised litters.

d. Doyan.—The Filipino doyan (pronounced doo-yan) consists of a hammock swung on two long bamboo poles, the latter resting on the outer shoulders of four bearers.

■ 16. EMPLOYMENT OF LITTER BEARERS OF MEDICAL DETACHMENTS.—See FM 8-10.

■ 17. EMPLOYMENT OF LITTER BEARERS OF COLLECTING UNITS.—See FM 8-10.

SECTION II

INSTRUCTION IN THE USE OF THE LITTER

■ 18. GENERAL.—*a. Purpose.*—The purpose of this section is to provide guides for instructing personnel in methods of handling litters and litter cases. Their general use will secure uniformity in the proper methods of performing a highly important function of medical service, and, at the same time, save valuable training time.

b. Scope.—This section includes proper methods of handling, opening, closing, and strapping litter; loading, carrying, and unloading of patients; and the actions of bearers upon encountering unusual situations, such as obstacles, stairs, and unusual injuries.

c. Commands.—Although not to be considered a precision drill, certain commands should be utilized to facilitate instruction. The use of these commands in actual operations is not contemplated.

■ 19. LITTER SQUAD.—*a. Composition.*—A litter squad (fig. 42), both for purposes of instruction and for actual field employment, ordinarily will consist of four bearers. Fewer are unable to withstand the fatigue of long and frequent carries, except when aided by a wheeled litter carrier or similar device.

b. Designation of bearers.—During instruction, each bearer will be given a numerical designation. Members of a litter squad, being in line, are numbered consecutively from right to left. No. 1 is the squad leader; in his absence, No. 4 commands; if both Nos. 1 and 4 are absent, No. 3 becomes the squad leader.

c. Duties in reduced squads.—Nos. 3 and 2 being absent, their duties are assumed by Nos. 1 and 4, respectively. No. 1



FIGURE 42.—Litter squad.

being absent, No. 4 assumes his duties. In his absence, the duties of No. 4 do not require replacement.

d. Instruction in reduced squads.—Under exceptional circumstances, when 2-bearer squads are being instructed, the instruction will be as for Nos. 2 and 3 of the 4-bearer squad.

■ 20. LITTER, STRAPPED AND CLOSED.—*a. Litter, strapped.*—The aluminum pole litter is said to be strapped (fig. 43) when it is folded, the canvas doubled smoothly, and secured by the cross straps. The wooden pole litter is said to be strapped (fig. 44) when it is folded, the canvas doubled smoothly on top, the slings placed thereon parallel to each other, and all secured by the cross straps.

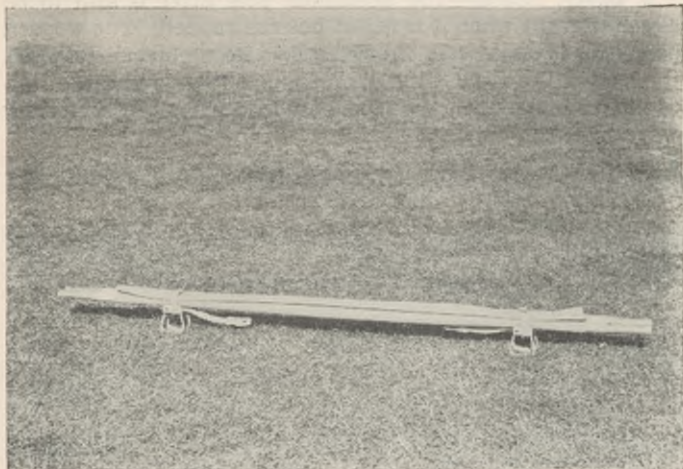

FIGURE 43.—Aluminum pole litter, strapped.

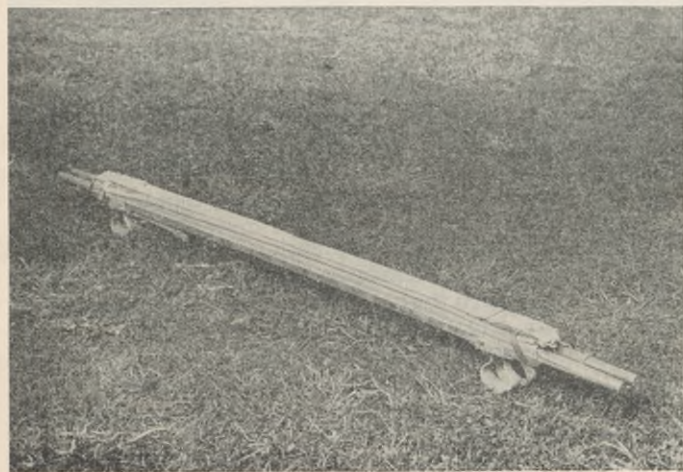

FIGURE 44.—Wooden pole litter, strapped.

b. Litter, closed.—The aluminum pole litter is said to be closed (fig. 45) when it is folded but unstrapped. The wooden pole litter is closed (fig. 46) when it is folded but unstrapped, the loop of the front sling upon the left handle and the loop of the rear sling upon the right handle, the bight of each sling embracing the opposite handle.

■ 21. INSTRUCTION WITH UNLOADED LITTERS.—*a. Formation for instruction.*—Being in its normal formation, to form and aline the unit (detachment, platoon, or company) in a single rank

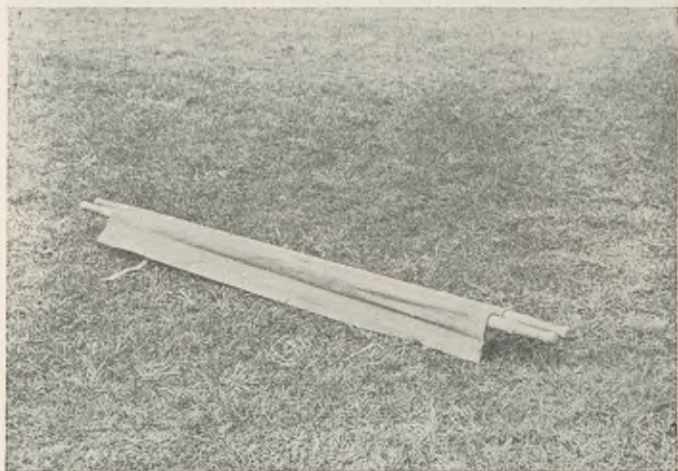

FIGURE 45.—Aluminum pole litter, closed.

for instruction in the litter, appropriate commands from FM 22-5 will be employed. Similarly, following completion of the instruction, to return the unit to its normal formation, appropriate infantry drill commands will be employed.

b. Formation of litter squads.—The unit being in single rank facing the front, to form litter squads, the commands are: 1. COUNT, 2. FOURS. At the command FOURS, all except the right file execute EYES RIGHT, and, beginning with the right file, count *one, two, three, four, one, etc.*; each man turns his head and eyes to the front as he counts.

c. Designation of squads.—Litter squads being formed, to designate squads by number, the commands are: 1. COUNT, 2. LITTER SQUADS. At the command LITTER SQUADS, No. 1 of each squad except the right squad, executes EYES RIGHT, and, beginning on the right, counts, in consecutive order, *one, two, three, etc.*, until all have counted. Each No. 1 turns his head and eyes to the front as he counts.

d. Procurement of litters.—Being in proper formation (fig. 47) and litters being available in the immediate vicinity, for

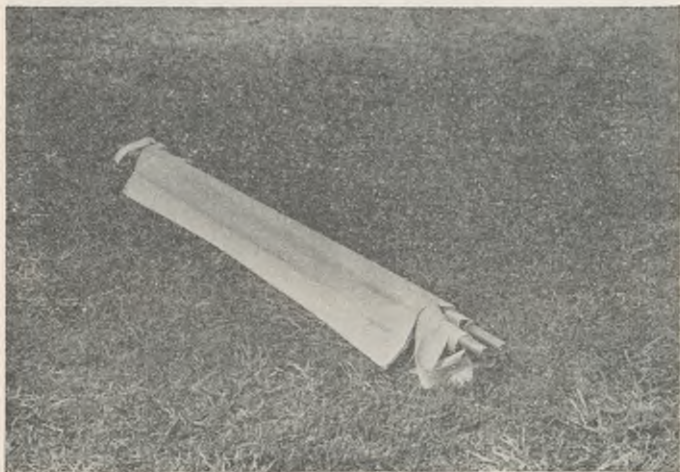

FIGURE 46.—Wooden pole litter, closed.

each litter squad to procure one litter, the commands are: 1. PROCURE, 2. LITTER. At the command LITTER, all Nos. 3 step one pace to the rear (fig. 48), execute RIGHT (LEFT) FACE, as required by the location of the litters, and immediately proceed in column of files by the nearest route to the (closed or strapped) litters. Each takes one litter, placing it on the right shoulder (see *f* below), and all promptly return in reverse order to the rear of the line (fig. 49), turn, and step into the line in unison (fig. 50), litters at the vertical. Upon arriving in position, Nos. 3 bring litters to the shoulder

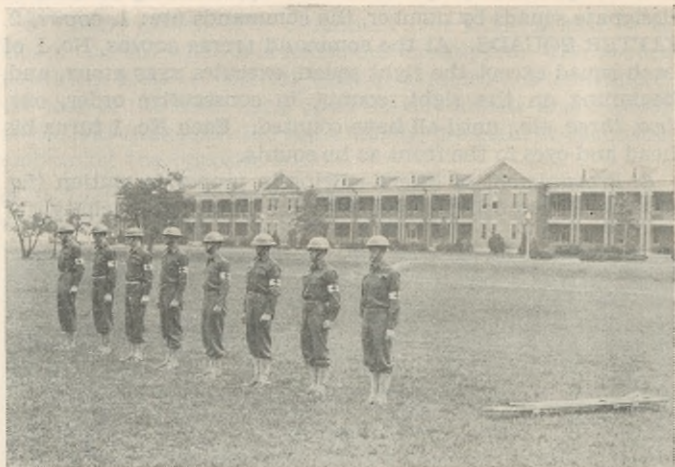

FIGURE 47.—Formation for instruction in the litter.



FIGURE 48.—PROCURE, LITTER, first step.



FIGURE 49.—Nos. 3 halted in rear of line.



FIGURE 50.—Nos. 3 in line, litters vertical.

(fig. 51). This march should be supervised by a noncommissioned officer. It can be executed in double time.

e. Return of litters.—Instruction having been completed, to return litters to place of procurement, the commands are: 1. RETURN, 2. LITTER. This movement is executed in the same manner as PROCURE, LITTER, except that the litters are carried from, instead of toward, the unit.

f. Litter at the shoulder (fig. 52).—In the position “at the shoulder,” the litter is held at a 45° angle, canvas down, upon



FIGURE 51.—PROCURE, LITTER, completed.

the right shoulder, the right hand grasping the lower right stirrup; the left hand is dropped to the side. In all motions from the shoulder or to the shoulder, the litter should be brought to vertical position (fig. 53) against the right shoulder, canvas to the rear, right hand grasping right lower stirrup, left forearm horizontal, and left hand steadying the litter against the shoulder. The vertical position should be taken automatically by the bearer when resuming his place in line (see *d* above) and in any formation or movement in which there may be danger of the handles of the litter striking



FIGURE 52.—Litter at the shoulder.



FIGURE 53.—Litter at the vertical.

neighboring men, after which "at the shoulder" is resumed without command.

g. To order litter (fig. 54).—Being at the shoulder, to order litter, the commands are: 1. ORDER, 2. LITTER. At the command LITTER, the litter is brought to vertical position, the lower handles then dropped to the ground outside the right foot, canvas to the rear, right arm extended naturally, right hand grasping the poles, and left hand dropped to the side.

h. To shoulder litter.—(1) *From the order.*—Being at the order, to shoulder litter, the commands are: 1. SHOULDER, 2. LITTER. At the command LITTER, the litter is lifted with the left hand (fig. 55) to the vertical position (fig. 53), then raised until the left wrist is level with the chin, when it is laid, canvas down, upon the shoulder as described in *f* above (fig. 52).

(2) *From the carry.*—Being at the carry (see *i* below), to shoulder litter, at the command LITTER, No. 3 advances to his former position in line, at the same time bringing the litter to vertical, and then to shoulder position. In this he is aided by No. 2 who lifts his end of the litter to the vertical as he steps backward into his former position in line. Nos. 1 and 4 stand fast.

i. To carry litter.—(1) *Being in line.*—Being in line, litters at the shoulder, to carry litter the commands are: 1, CARRY, 2. LITTER. At the command LITTER, each No. 3 brings his litter to the vertical position, steps backward two paces (fig. 56), drops the upper handles forward and downward until the litter is in horizontal position, canvas up, and grasps the outside handle with his right hand; meanwhile, No. 2 steps directly to the front until he is opposite the front handles, when he grasps the outside handle with his left hand (fig. 57); Nos. 1 and 4 stand fast (fig. 58); guides, if any, aline on Nos. 1 and 4.

(2) *Being at the ground.*—Being at the ground, to carry litter, at the same command, Nos. 3 and 2, using their right and left hands, respectively, stoop, grasp the outside handles (fig. 59), and raise the litter from the ground to the carry.

(3) *Designation of litter ends.*—That portion of the litter normally supported by No. 2 is the foot or front; that by No. 3, the head. With the exception of a few special move-

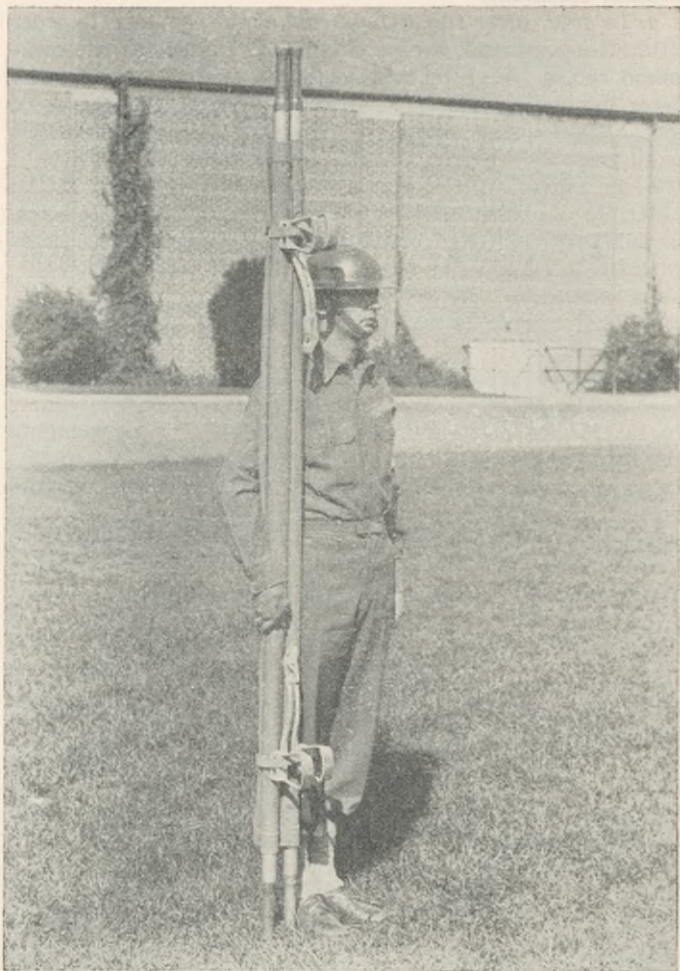

FIGURE 54.—Litter at the order.



FIGURE 55.—SHOULDER, LITTER, first step.



FIGURE 56.—CARRY, LITTER from shoulder, first step.



FIGURE 57.—CARRY, LITTER from shoulder, second step.

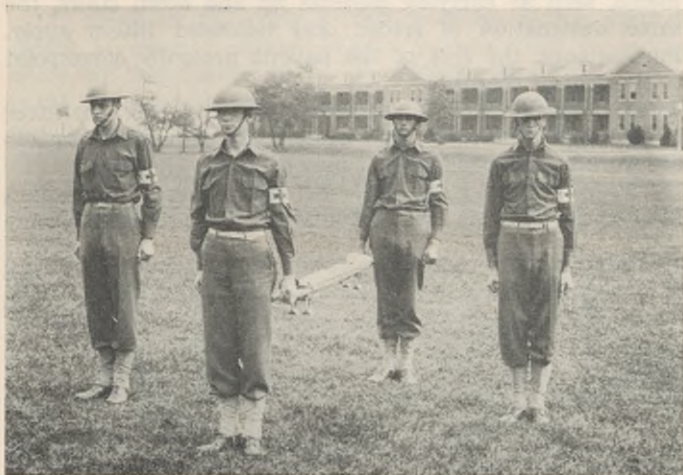

FIGURE 58.—CARRY, LITTER, completed.



FIGURE 59.—CARRY, LITTER from ground, first step.

ments, such as carrying patients up and down stairs, the same designation of loaded and unloaded litters apply. Furthermore, the feet of the patient normally correspond to the foot of the litter.

(4) *Unloaded litter in marching.*—In marching, the litter is usually at the carry, but when space permits or squads are working independently, it may be at the shoulder.

j. To ground litter (fig. 60).—Being at the carry, to ground litter, the commands are: 1, GROUND, 2, LITTER. At the com-

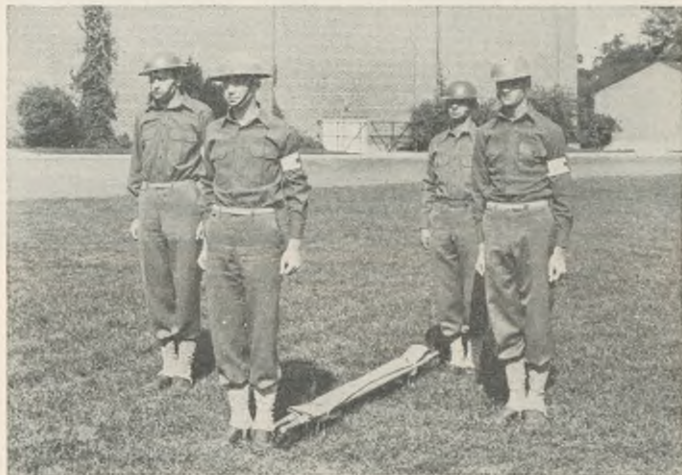

FIGURE 60.—Litter at the ground.

mand LITTER, Nos. 3 and 2 stoop and lower litter to the ground, canvas up, release the handles, and resume erect position, facing front.

k. To change bearers.—(1) *Being at the carry.*—Being at the carry, in marching, to change bearers, the commands are: 1, CHANGE BEARERS, 2, MARCH. At the command MARCH, Nos. 1 and 4 step to the right rear and left front of the litter, respectively, and grasp the handles relinquished by Nos. 2 and 3, who step to right and left center, respectively.

(2) *Being at the ground, closed.*—Being at the ground, closed, to execute CHANGE BEARERS, bearers move as at the carry, but Nos. 1 and 4 do not grasp the handles.

(3) *Being at the ground, open.*—The litter being at the ground, open, to execute the same command, Nos. 1 and 4 assume the rear and front posts, respectively, while Nos. 2 and 3 assume right and left posts, respectively, thus all describing part of a circle in a clockwise direction around the litter.

l. To open litter.—Being at the carry, litter strapped, to open litter, the commands are: 1. OPEN, 2. LITTER. At the command LITTER, all bearers face the litter (fig. 61); No. 4 supports the litter at the center, canvas up (fig. 62); Nos. 2 and 3 unfasten straps, button straps to their respective studs if it be a litter so equipped, and grasp the left handles with their left hands, leaving the litter suspended longitudinally, canvas to the right (fig. 63); Nos. 2 and 3, assisted by Nos. 1 and 4, extend the braces (fig. 64) and, supporting the litter horizontally, canvas up, lower it to the ground, when all resume their positions at litter posts. If the litter is closed, but not strapped, so much of this directive as relates to the unfastening of the straps does not apply. If the litter is equipped with slings, Nos. 2 and 3 slip the free loop of their respective sling upon the ring handle, the bight embracing the opposite handle.

m. To secure slings.—(Applicable to litter with slings attached.) Unsecured slings tend to drag the ground, catch on small obstacles, and, at times, actually interfere with loading ambulances and similar operations. This may be avoided by securing slings. To secure slings, the litter being lowered, the commands are: 1. SECURE, 2. SLINGS. At the command SLINGS, Nos. 2 and 3 slip the loop end of the sling over the ring handle (fig. 65). Each drops the double end over the free handle and brings it up around the handle, slipping the the double end through the sling (fig. 66) and over the end of the handle (fig. 67).

n. To close litter.—Being open, to close litter, the commands are: 1. CLOSE, 2. LITTER. At the command LITTER, Nos. 2 and 3 step outside the right front and left rear handles, respectively, and face inward; they stoop and, with



FIGURE 61.—OPEN, LITTER, first step.



FIGURE 62.—OPEN, LITTER, second step.

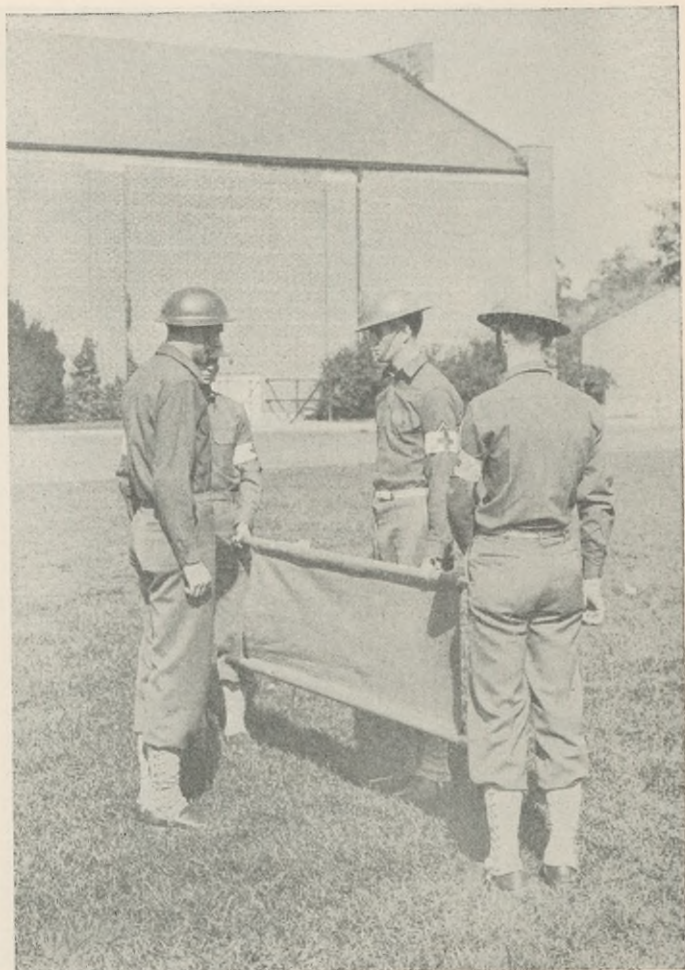

FIGURE 63.—OPEN, LITTER, third step.



FIGURE 64.—OPEN, LITTER, fourth step.

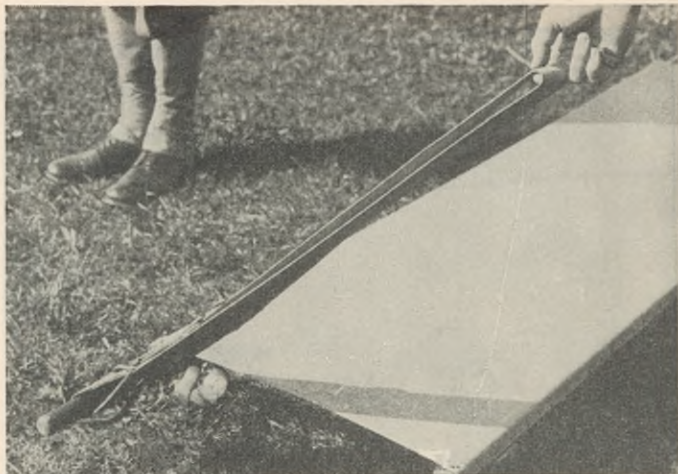

FIGURE 65.—SECURE, SLINGS, first step.

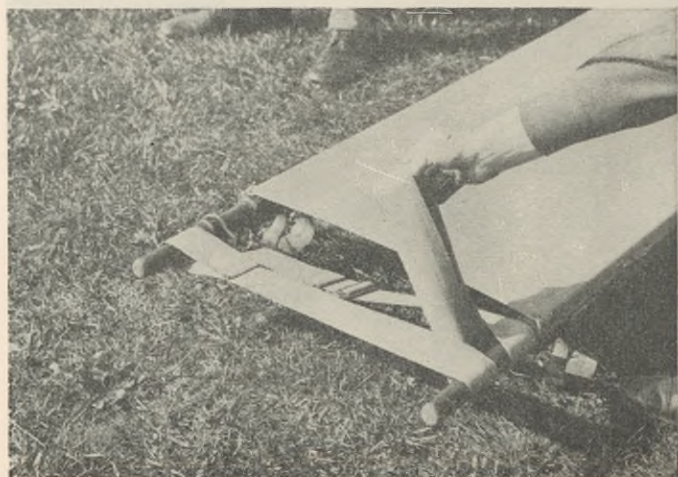

FIGURE 66.—SECURE, SLINGS, second step.

their right hands, raise the litter by the left handles; they then fold the braces and, bringing the lower pole against the upper, support the litter at the carry.

o. To strap litter.—The litter being closed, to strap litter, the commands are: 1. STRAP, 2. LITTER. At the command LITTER, all face the litter; No. 4 supports the litter at the center (fig. 68); Nos. 2 and 3, assisted by No. 1, fold canvas by doubling it smoothly on top of the poles (fig. 69), release free loops of slings if litter have slings attached, place them

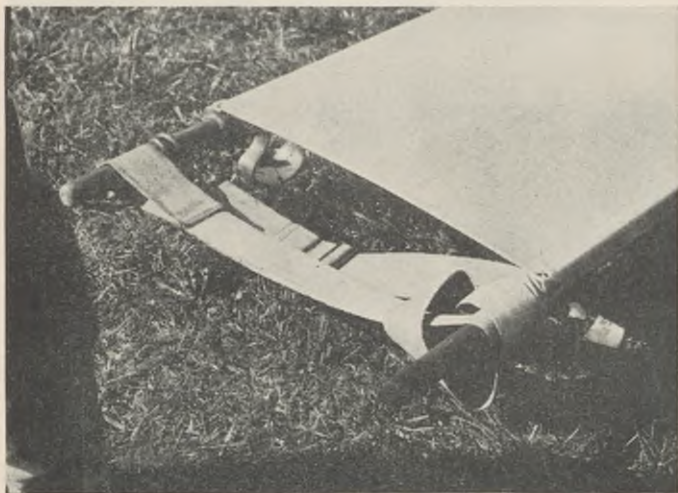

FIGURE 67.—SECURE, SLINGS, completed.

on the canvas, buckles out, and secure all by the cross straps at each end, passing them through the loops of the slings (fig. 70) if any, when all take their posts at the carry. In the field, the litter should be carried strapped or closed, and opened only upon reaching the patient. The litter being open, may be closed and strapped at the command STRAP, LITTER, in which case the procedures outlined are both executed in rotation, at the one command (see also *n* above).

p. To bring litter squad into line.—During litter instruction, it may be desired to move the squad, without litter, to



FIGURE 68.—STRAP, LITTER, first step.



FIGURE 69.—STRAP, LITTER, second step.

another point. Bearers being at posts with litter at the ground, to bring the squad into line, the commands are: 1. FORM, 2. RANK. At the command RANK, No. 2 advances one pace and remaining bearers move forward and aline themselves on him, in regular order (fig. 71).

q. To resume litter posts.—Normal bearer posts, with the litter at the ground, may be recovered at any time by the commands: 1. LITTER, 2. POSTS. At the command POSTS, all members of the squad move by the nearest route and resume posts as shown in figure 60.

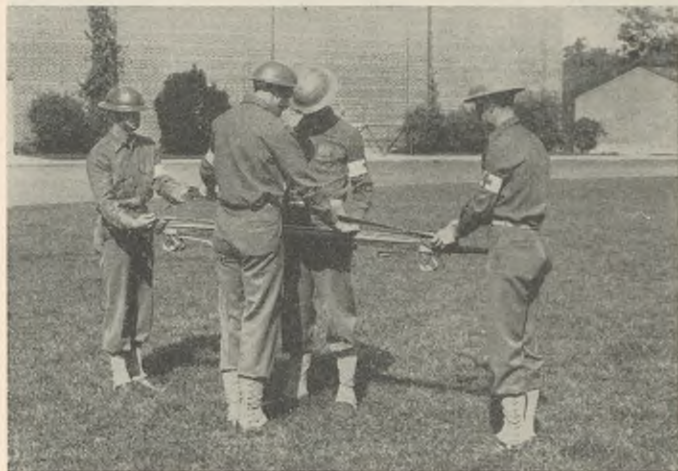

FIGURE 70.—STRAP, LITTER, third step.

r. To lift open litter, loaded or unloaded.—(1) *Aluminum pole litter.*—Being at the ground with bearers at litter posts, to lift the aluminum pole litter utilizing the litter-carrying straps, the commands are: 1. PREPARE TO LIFT, 2. LIFT. At the first command, Nos. 2 and 3 remove their litter-carrying straps from their pouches, attach them to their suspenders, then stoop and grasp handles firmly. Meanwhile, Nos. 1 and 4 face litter, stoop and grasp adjacent pole (fig. 72). At the command LIFT, Nos. 2 and 3 arise slowly, assisted in lifting by Nos. 1 and 4, following which Nos. 1 and 4 adjust the



FIGURE 71.—Squad at FORM, RANK.

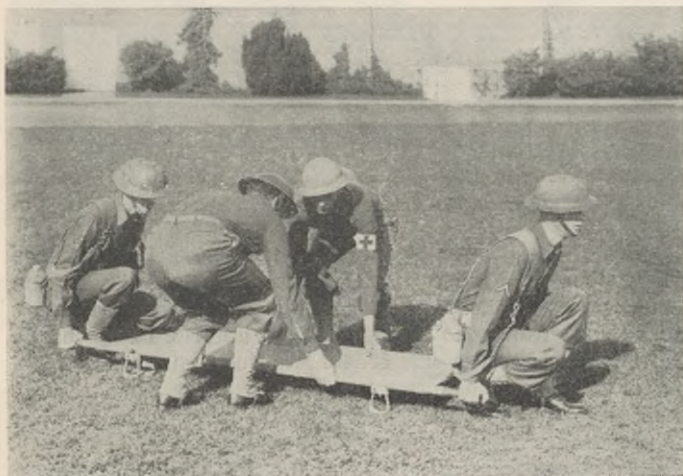

FIGURE 72.—Squad at PREPARE TO LIFT, with straps.

litter-carrying straps of Nos. 2 and 3, respectively, then resume their posts (fig. 73). The litter may be lifted without litter-carrying straps by prefixing **WITHOUT LITTER-CARRYING STRAPS** to the command.

(2) *Wooden pole litter.*—Being at the ground with bearers at litter posts, to lift the open wooden pole litter, at the command **PREPARE TO LIFT**, Nos. 2 and 3 stoop, slip the slings off the handles and place them over their shoulders; they then replace the free loop upon its handle and firmly grasp the

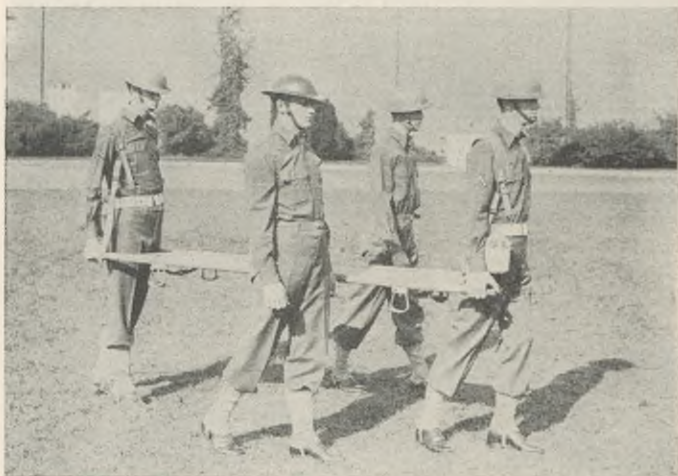

FIGURE 73.—Litter lifted, with straps.

handles of the litter. At the same time, Nos. 1 and 4 face litter, stoop, and grasp the adjacent pole (fig. 74). At the command **LIFT**, all lift the litter, arising slowly until erect. No. 4 then advances to the side of No. 2 and No. 1 steps backward obliquely to the side of No. 3, adjusts slings, lengthening or shortening as necessary to level litter, then resume their posts (fig. 75). The litter may be lifted without slings by prefixing **WITHOUT SLINGS** to the command.

s. *To march forward.*—Being at the lift, to march forward, the commands are: 1. **FORWARD**, 2. **MARCH**. At the command **MARCH**, No. 2 steps off with the left foot, No. 3 with the



FIGURE 74.—Squad at PREPARE TO LIFT, with slings.

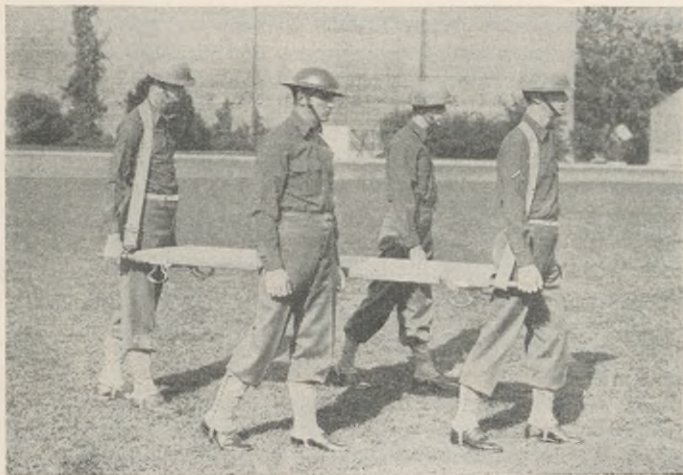

FIGURE 75.—Litter lifted, with slings.

right, both taking short, sliding steps of about 20 inches, to avoid jolting and to secure uniform motion of the litter. Nos. 1 and 4 step off with the left foot, employing the normal pace at a cadence to conform with the progress of Nos. 2 and 3.

t. To lower litter.—Being at the lift, to lower litter, the commands are: 1. LOWER, 2. LITTER. At the command LITTER, Nos. 2 and 3 slowly lower litter to the ground, disengage litter-carrying straps from litter handles, and resume erect position. Or, if employing litter with slings, Nos. 2 and 3, after lowering litter, seize the free loop and bight of their respective slings from their shoulders, place loops upon ring handles, the bights embracing opposite handles, then resume erect position. The open litter should be lifted and lowered slowly without jerks, both ends simultaneously, the rear bearer moving in accord with the front bearer so as to maintain a horizontal canvas. The open litter, unloaded, for purposes of instruction should be handled as a loaded litter and as soon as the men are familiar with the handling of the unloaded litter, instruction should be with the loaded litter.

■ 22. INSTRUCTION WITH LOADED LITTERS.—*a. General.*—(1) *Patients for purposes of instruction.*—For purposes of instruction with loaded litters, certain men are designated "patients." To make the instruction more realistic and to instruct in the handling of different types of injuries, patients should wear bandages and splints to simulate actual disabilities. In early periods of instruction, these patients will be placed on the ground at suitable intervals near the line of litters, first with the heads and later with the feet toward the line. As the instruction progresses, the positions may be varied and, lastly, dispersed or concealed in such positions as they would occupy on the battlefield. When patients are loaded on litters, their arms and accouterment are carried by Nos. 1 and 4 or placed on the litter.

(2) *Arrangement for instruction.*—Several squads may be instructed by the same individual at the same time, or each squad may be instructed separately by an instructor or by the squad leader (No. 1). In the latter case, squad leaders assume charge at a directive by the instructor or the unit commander.

At the signal for assembly, the squads form in line, lower litters, and come to rest, when the patients if still on the litters are divested of dressings and splints, and resume their posts. Further movements are performed as directed by the instructor.

(3) *General rules for moving patients.*—(a) In moving the patient, either with or without the litter, every movement should be made deliberately and as gently as possible, care being taken not to jar the injured part. The command **STEADY** will be used to prevent undue haste and other irregularities.

(b) The rear bearer should watch the movements of the front bearer and time his own with them, so as to insure ease and steadiness of action.

(c) As a rule, the patient should be carried on the litter feet foremost, but in going uphill or upstairs his head should be in front.

(d) In case of fracture of the lower extremities, he is carried uphill or upstairs feet foremost and downhill head foremost, to prevent the weight of the body pressing upon the injured part.

(e) In passing obstacles and ditches, the litter must be kept level at all times.

b. To load and unload litter.—(1) *Position for lifting patient.*—The patient having been located, the general nature of his wounds having been determined, and the litter being open and available, to place bearers in proper position to lift patient, the commands are: 1. **RIGHT (LEFT) SIDE**, 2. **POSTS**. At the command **POSTS**, bearers take position as follows: No. 2 at the right (left) ankle; No. 3 at the right (left) shoulder; Nos. 1 and 4 at the right and left hips, respectively, all facing the patient (fig. 76).

(2) *To lift patient and place litter in position.*—The bearers being at posts, to lift patient preparatory to placing him on the litter, the commands are: 1. **LIFT**, 2. **PATIENT**. At the preparatory command **LIFT**, all bearers kneel on knees nearest the patient's feet; No. 2 passes both forearms under the patient's legs, carefully supporting the fracture, if there is one; Nos. 1 and 4 place their arms under the small of the back and the thighs, not locking hands; No. 3 passes one

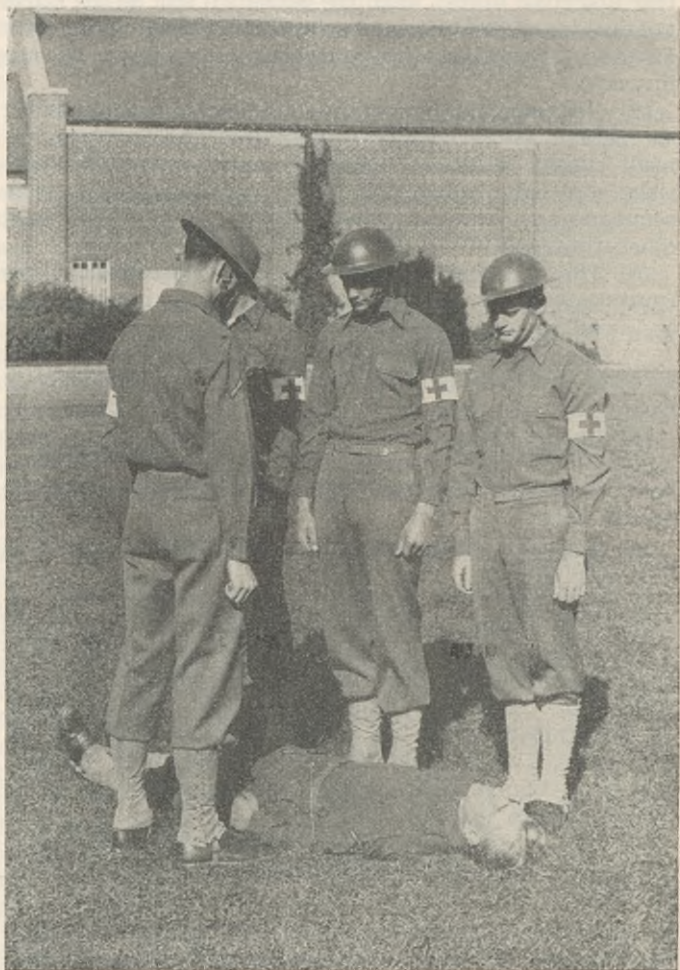

FIGURE 76.—Squad at RIGHT SIDE, POSTS.

hand under the patient's neck to the farther armpit, with the other supporting the nearest shoulder (fig. 77). At the command **PATIENT**, all lift together, slowly and carefully, and place the patient upon the knees of the three bearers on the same side (fig. 78). As soon as he is firmly supported there, the bearer on the opposite side (No. 1 or 4) relinquishes his hold, passes quickly by the nearest route to the litter which he takes up by the middle, one pole in each hand, and, returning rapidly, places it under the patient and against the ankles of the other three bearers (fig. 79).



FIGURE 77.—Squad at LIFT.

(3) *To lower patient on litter.*—The patient being on the knees of three bearers, and the litter being in proper position to receive the patient, to lower patient on litter, the commands are: 1. **LOWER**, 2. **PATIENT**. At the command **LOWER**, the free bearer (No. 1 or 4) resumes his former kneeling position opposite the other three bearers and prepares to assist in lowering the patient. At the command **PATIENT**, the patient is lowered gently upon the litter, made as comfortable as possible, then without further orders all bearers rise and resume their positions at litter posts.



FIGURE 78.—First step after command PATIENT.



FIGURE 79.—Litter being placed beneath patient.

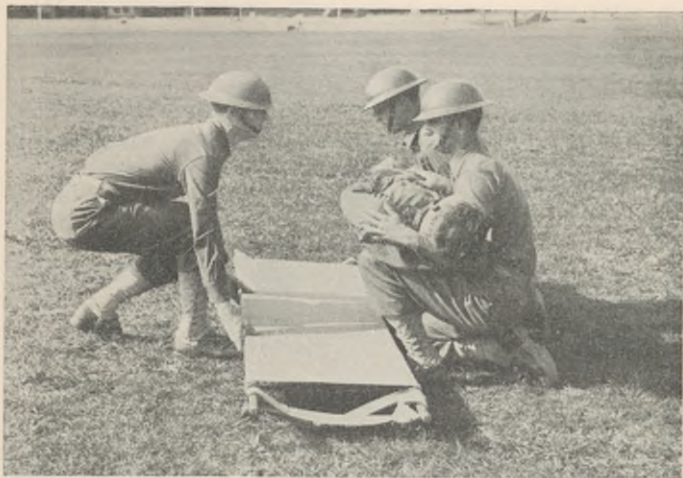

FIGURE 80.—Loading litter with three bearers.



FIGURE 81.—Lowering patient on litter.



FIGURE 82.—Two bearers at RIGHT SIDE, POSTS.

(4) *To unload litter.*—The patient being on the litter, to unload litter, the same commands are given and the actions of the bearers are the same, with the following exception: after the patient has been lifted to the knees of the three bearers, the free bearer removes the litter from beneath the patient instead of placing it under him.

c. *To load and unload litter with three bearers.*—In the absence of one man from the litter squad, No. 3 or 2 is replaced by No. 4 or 1, respectively, while Nos. 1 and 4 replace each



FIGURE 83.—Actions of two bearers at LIFT.

other. With three bearers, the litter is placed as usual and, at the prescribed commands, the bearers take their proper positions. The patient, having been lifted by the three bearers, is supported on the knees of the two on one side, while the third (No. 1 or 4) places the litter in position (fig. 80). In like manner, the patient is lowered on the litter (fig. 81). To unload the litter, the maneuvers are reversed.

d. *To load litter with two bearers.*—(1) *With bearers on the same side.*—At the command RIGHT (LEFT) SIDE, POSTS, Nos. 2 and 3 take positions at patient's right (left) thigh and



FIGURE 84.—Two bearers at command patient.

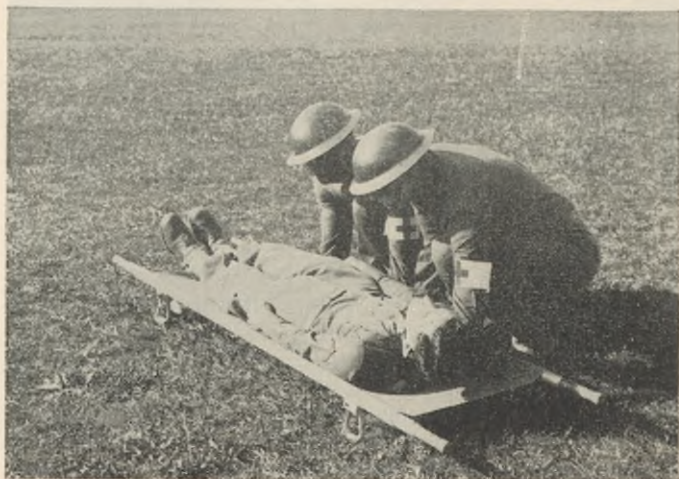

FIGURE 85.—Two bearers placing patient on litter.

shoulder, respectively (fig. 82). At the command **LIFT**, bearers kneel on knees nearest the patient's feet; No. 2 passes his arms beneath the patient's hips and knees; No. 3 passes his arms beneath the patient's shoulders and small of his back (fig. 83). At the command **PATIENT**, they lift together, raising the patient upon their knees, then, readjusting their holds, rise to their feet and carry patient to the side of the litter. At the command **LOWER, PATIENT**, the bearers kneel and place the patient on their knees (fig. 84), stoop forward and place him on the litter (fig. 85), then rise and assume the position of **LITTER POSTS** without command. To unload, posts are taken in the same way, at the same commands.

(2) *With bearers on opposite sides.*—In case the patient is conscious and able to cooperate in the movement, a method whereby the bearers take positions on opposite sides of the patient may be employed. To carry out this movement, the commands are: 1. **BOTH SIDES**, 2. **POSTS**. At the command **POSTS**, Nos. 2 and 3 take positions at the patient's right and left hips, respectively, facing the patient (fig. 86). At the command **LIFT**, bearers kneel on the knees nearest the patient's feet, raise him to a sitting position, and pass their arms around his back and under his thighs, locking hands. The patient, if able, clasps his arms around the bearers' necks (fig. 87). At the command **PATIENT**, they lift the patient, both rising together, and carry him to the center of the litter (fig. 88). At the command **LOWER, PATIENT**, they stoop and lower the patient upon the litter in a sitting position, and the patient releases his hold on the bearers' necks (fig. 89). No. 3 then passes his left hand across the front of the patient's chest to the opposite armpit and grasps the patient. No. 2 releases his hold at the right side of the patient, steps astride the patient's lower extremities, and grasps the patient's right and left thighs just above the knees with his left and right hands, respectively. Both bearers then turn and lower the patient upon the litter, head toward No. 3, when both bearers take the position of **LITTER POSTS** without command. Unloading is performed, in reverse order, at the same commands.



FIGURE 86.—Two bearers at BOTH SIDES, POSTS.

e. To load and unload back cases.—To avoid aggravating the condition of patients with actual or suspected back injuries, the following procedure will be followed:

(1) *To place patient face down.*—The patient being in the prone position on his back, a blanket rolled or folded lengthwise to two-thirds its normal width is placed alongside the patient, the roll or fold in close proximity to his body (fig. 90). At the command *ROLL*, No. 2 kneels at the patient's feet, firmly grasping the patient's ankles; No. 3 kneels at the patient's head, hands grasping the patient's chin and occiput (back of



FIGURE 87.—Two bearers ready to lift patient.

head). No. 1 kneels by the side of the patient, opposite the blanket, while No. 4 places an open litter in close proximity, and prepares to assist No. 1. At the command *PATIENT*, Nos. 2 and 3 exert moderate traction, while Nos. 1 and 4 gently roll the patient over on the blanket, face down, arms extended over his head, forearms supporting his head (figs. 91 and 92).

(2) *To place on litter.*—At the command *LIFT*, No. 2 grasps the lower end of the blanket, No. 3 the left half of the upper end and the upper half of the left side, and No. 1 grasps the right half of the upper end and the upper half of the



FIGURE 88.—Two bearers ready to lower patient.



FIGURE 89.—Bearers depositing patient on litter.

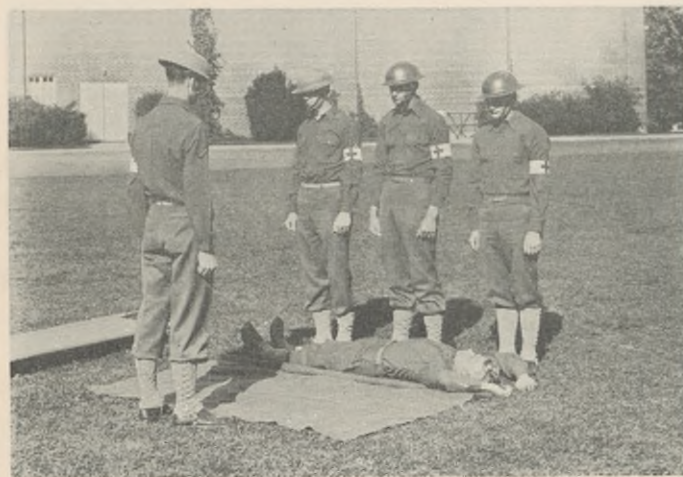

FIGURE 90.—Rolled blanket alongside back case.



FIGURE 91.—Back case being rolled onto blanket.

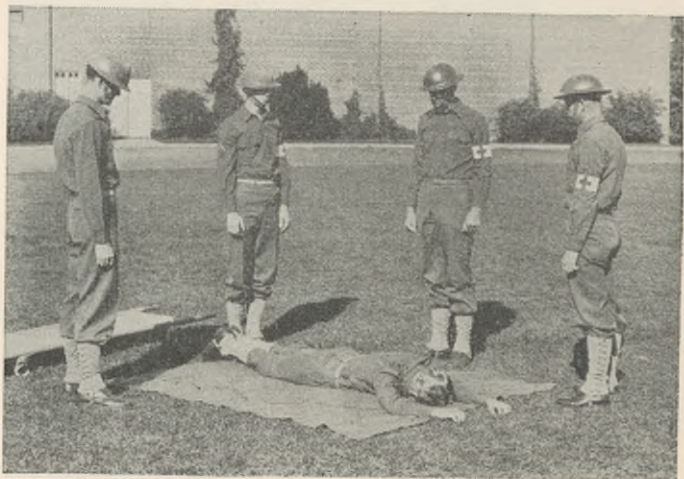

FIGURE 92.—Back case face down on blanket.



FIGURE 93.—Back case being placed on litter.

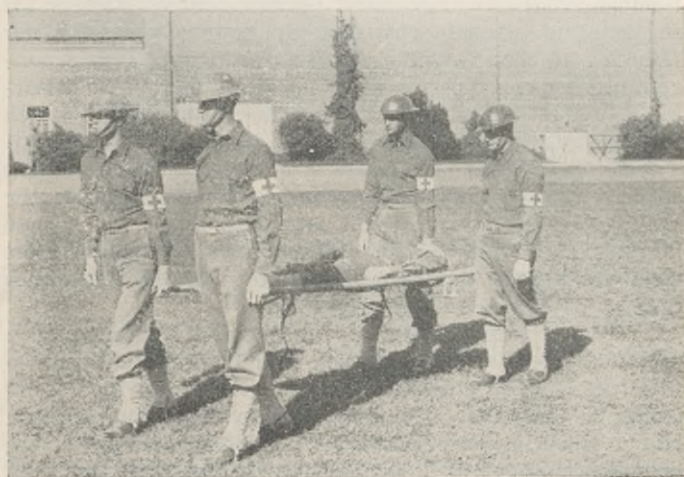

FIGURE 94.—Loaded litter carried by four bearers.

right side. At the command **PATIENT**, Nos. 1, 2, and 3 lift patient on the blanket, while No. 4 places the open litter beneath the patient (fig. 93). At the command **LOWER, PATIENT**, Nos. 1, 2, and 3, assisted by No. 4, lower the patient gently down on the litter.

(3) *To unload from litter.*—To unload the patient from the litter, the same maneuvers, at the same commands, are executed in reverse order.

f. To carry loaded litter by four bearers.—If it is desired that the four bearers carry the loaded litter, while marching, the commands are: 1. **BY FOUR**, 2. **CARRY**, 3. **LITTER**. At the command **LITTER**, No. 1 steps backward to the right rear, No. 4 forward to the left front, and each grasps the handle nearest him, relinquished by Nos. 2 and 3, respectively, who, retaining their grasp on the other handles, move to the outside (fig. 94). Normal positions are resumed by the command **LITTER, POSTS**.

■ 23. **TO PASS OBSTACLES.**—*a. General.*—Obstacles include fences, walls, cuts, ditches, running streams, or other natural or artificial impediments. Obstacles should be avoided when feasible, otherwise they must be surmounted. Orders for surmounting separate obstacles are neither necessary nor feasible. Hence, flexibility in the execution of orders concerning obstacles must be maintained, common sense dictating details of action most suited to the situation with which the bearers may be confronted.

b. To pass minor obstacles.—For crossing wide, shallow streams, rough or cultivated ground, or similar obstacles, the command is **OBSTACLE**. At this command, Nos. 1 and 4 close in, grasp the centers of the adjacent poles, and give support until the obstacle has been surmounted (fig. 95), then they resume their posts without command.

c. To pass major obstacles.—To pass over fences, ditches, and similar obstacles, when Nos. 2 and 3 must entirely release the litter to cross such obstacle, the orders are: 1. **OBSTACLE**, 2. **MARCH**. At the preparatory command **OBSTACLE**, Nos. 1 and 4 move as outlined in subparagraph *b*. At the command **MARCH**, No. 2 relinquishes his grasp on the front handles, removes the slings from his shoulders and places them on the litter (or disengages the litter-carrying straps),

and crosses the obstacle (fig. 96). The litter being advanced by the other three bearers, No. 2 grasps the front handles and, after further aiding in advancing the litter, assists No. 3 in steadying it while Nos. 1 and 4 cross the obstacle (fig. 97). The litter is then lifted over and across the obstacle by Nos. 1, 2, and 4, while No. 3 crosses and resumes his grasp on the rear handles. Nos. 1 and 4, after assisting Nos. 2 and 3 in adjusting slings, if any, resume their posts without command.



FIGURE 95.—Carrying litter over minor obstacles.

d. To surmount obstacles over 5 feet high.—The squad being in position of **BY FOUR, CARRY, LITTER**, to surmount an obstacle over 5 feet high, the commands are: 1. **RAISE**, 2. **LITTER**. At the command **LITTER**, the litter is raised carefully to the level of the obstacle and advanced until the front feet of the litter have cleared, or become well anchored on, the obstacle (fig. 98); Nos. 2 and 4 then clear the obstacle, assist in advancing the litter to the rear feet, then steady it while Nos. 1 and 3 clear the obstacle and resume their grasp on the rear handles. Upon clearing, the litter is lowered to its former level without command.



FIGURE 96.—Crossing low obstacle, first step.



FIGURE 97.—Crossing low obstacle, second step.

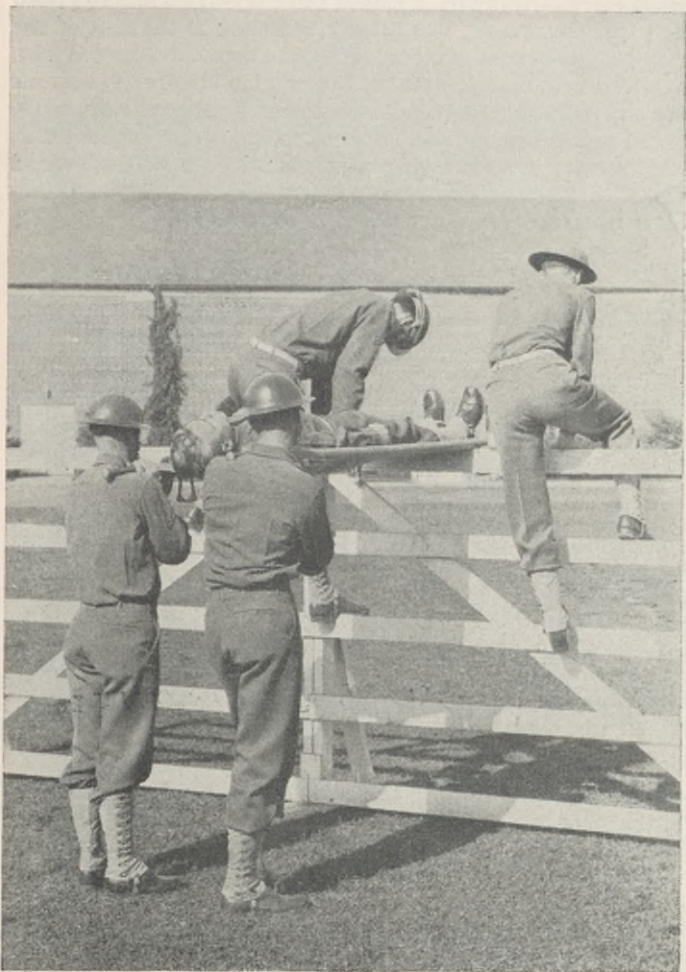

FIGURE 98.—Surmounting obstacle over 5 feet.

■ 24. TO CARRY LOADED LITTER UP AND DOWNSTAIRS.—*a. Upstairs carry.*—Normally, a loaded litter is carried upstairs head first (see par. 22a). The litter is marched to the foot of the stairs in the usual manner, wheeled about, and halted (fig. 99). To negotiate the stairs, the commands are: 1. PREPARE FOR STAIRS, 2. MARCH. At the command PREPARE FOR STAIRS, Nos. 1 and 4 face inward, advance to the center of the litter, and support it by grasping a pole with both hands; Nos. 2 and 3 slip free loops of slings off handles (or disengage litter-carrying straps), face about and again grasp the handles (fig.



FIGURE 99.—Upstairs carry, first step.

100); No. 4 then steps to the handle nearest him, at the foot of the litter, which he grasps firmly with both hands (fig. 101) while No. 2 grasps the opposite handle. At the command MARCH, the litter is carried upward by Nos. 2, 3, and 4 (fig. 102), the rear bearers being responsible for maintaining the level of the litter. No. 1 falls out, accompanies the litter, and renders assistance as required. When only three bearers are present, the litter must be lowered before the first command. After the stairs have been negotiated, normal positions are resumed by the command LITTER, POSTS. Or, if only three



FIGURE 100.—Upstairs carry, second step.



FIGURE 101.—Upstairs carry, third step.



FIGURE 102.—Upstairs carry, fourth step.



FIGURE 103.—Downstairs carry.

bearers be present, the litter must be lowered before resuming normal positions.

b. Downstairs carry.—Normally, a loaded litter is carried downstairs feet first (see par. 22*a*). The loaded litter is carried to the head of the stairs in the usual manner and halted. At the command PREPARE FOR STAIRS, No. 4 advances to the left front handle, which he grasps firmly with both hands, while No. 2 grasps the opposite handle (fig. 103). At the command MARCH, the litter is carried downward, Nos. 2 and 4 keeping the litter as nearly level as possible, No. 3, aided by No. 1, carefully observing the patient to insure no untoward incident during the descent. Upon reaching the foot of the stairs, normal positions are resumed by the command LITTER, POSTS.

c. With fractures of the lower extremity.—When the patient being transported has a fracture of the lower extremity, or if for any reason it be desired to carry the patient upstairs feet first, or downstairs head first, the bearers are reversed, in the former case No. 2 becoming the front bearer, in the latter, No. 3.

CHAPTER 4

ADJUNCTS TO THE LITTER IN THE TRANSPORTATION OF THE SICK AND WOUNDED

	Paragraphs
SECTION I. General	25-28
II. Instruction in the use of the wheeled litter carrier	29-31

SECTION I

GENERAL

■ 25. GENERAL.—The manual carrying of a loaded litter is one of the most grueling tasks performed by the personnel of the Medical Department. In prolonged actions, the *critical point* in the chain of evacuation within the division lies between the casualty on the field and the most forward ambulance. Therefore, every effort is made to minimize the task of litter bearers. Front line medical installations, including advanced ambulance loading posts, are placed as far forward as the situation and terrain will permit, and any mechanical device which will aid the litter bearers and accelerate the tempo of evacuation is employed whenever feasible. Among such mechanical aids is the carrier, field, commonly known as the wheeled litter carrier. (Fig. 104 shows World War, improvised, animal-drawn wheeled litter carriers.)

■ 26. WHEELED LITTER CARRIER (figs. 105 and 106).—*a. Description.*—The standard wheeled litter carrier is a collapsible, 2-wheeled cart, capable of transporting one loaded litter. Its weight is 59 pounds and its measurements are as follows: open—width 32½ inches, height over all 31 inches, length 28 inches; folded—9 by 28 by 61½ inches. Folded, it occupies approximately 10 cubic feet of space. Wheels are bicycle type with wire spokes, equipped with pneumatic tires size 26 by 2. It is equipped with two full elliptical springs upon which the litter is supported by a pair of angle brackets, held in position by a pair of screw brackets. The carrier, open, is kept in



FIGURE 104.—World War improvised animal-drawn wheeled litter carriers.

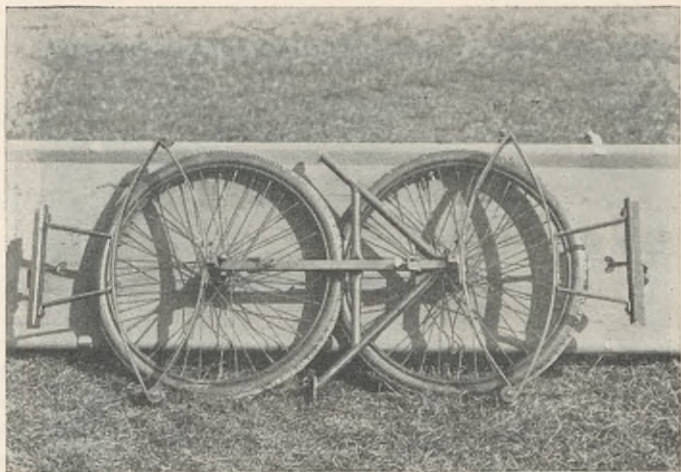

FIGURE 105.—Carrier, wheeled litter, collapsed.

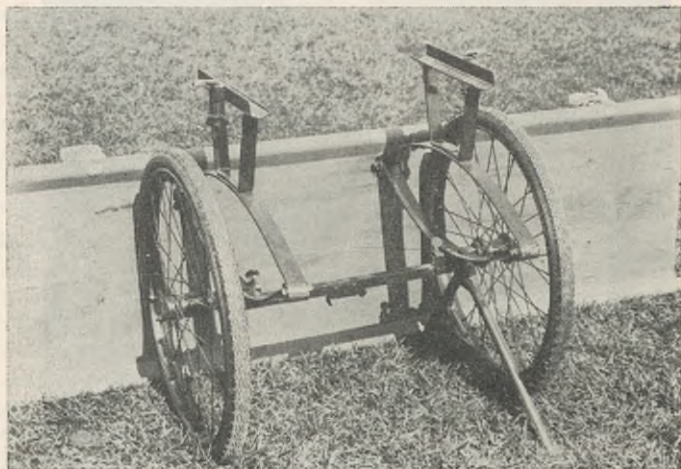

FIGURE 106.—Carrier, wheeled litter, open.

upright position by a hinged, tubular, metal, inverted V-shaped support stand which, when not in use, folds centrally from its lateral attachment to the axle rod, to be held in place by a spring latch. The preceding model (figs. 107 and 108), of which there are many in service and in depot storage, is similar in many respects. Its measurements approximate those of the standard carrier, but the wheels are wooden spoke, solid rubber tired, buggy type, and its weight is approximately 72 pounds.

b. Advantages of standard wheeled litter carrier.—(1) *Collapsibility.*—The shape plus the space requirements, assumed by the carrier when collapsed, facilitates its transportation to and from the place of actual employment, either as part of a top load or attached to the rear of an ambulance or truck by means of appropriate hooks.

(2) *Weight.*—There is a distinct reduction in weight over previous models.

(3) *Economy of personnel.*—Over suitable terrain, the litter squad employing the carrier may be reduced to two men, and the smaller squad still perform the same task with increased rapidity and less fatigue.

(4) *Employment in mud and sand.*—In consequence of the wide pneumatic tire, employment of the carrier in mud and sand becomes reasonably feasible.

(5) *Increased comfort for passenger.*—The pneumatic tires and elliptical springs increase the comfort of the patient being transported and, at the same time, decrease the tendency of the movement to cause or aggravate the condition of shock.

(6) *Safety factors.*—(a) *Balance.*—The vehicle is well balanced and the center of gravity is so located as to minimize the likelihood of over-turning.

(b) *Litter lock.*—The loaded litter is securely locked to the carrier during movement, thus precluding inadvertent or premature unloading. This also enables bearers to lift litter and carrier over minor obstacles without dismounting the litter.

(c) *Support stand.*—Safety during loading and unloading is insured by the stabilizing effect of the support stand.

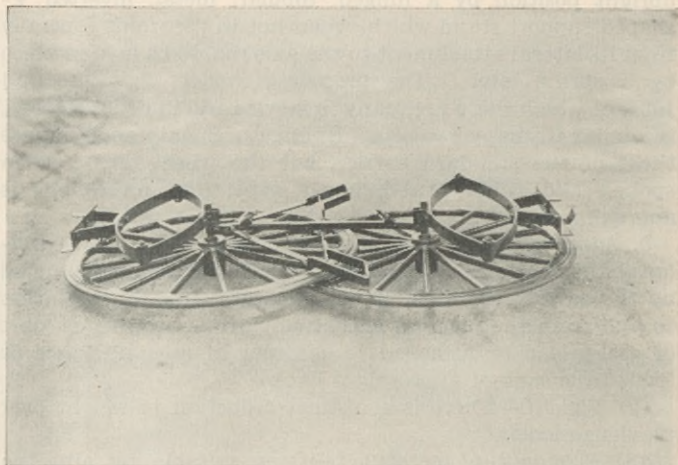

FIGURE 107.—Carrier, wheeled litter (old type) collapsed.

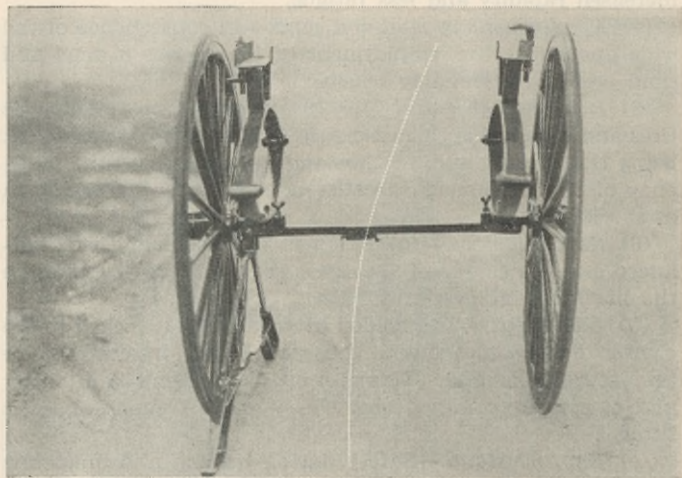

FIGURE 108.—Carrier, wheeled litter (old type) open.

■ 27. EMPLOYMENT OF WHEELED LITTER CARRIER IN THE FIELD.—See FM 8-10.

■ 28. SUBSTITUTES FOR WHEELED LITTER CARRIER.—*a. General.*—Frequently, situations arise wherein the following conditions obtain: the evacuation of sick or wounded mandatory; wheeled litter carrier either not available or use not feasible; ambulance either not available or its employment precluded; evacuation by bearers either too fatiguing, too time-consuming, or even impossible. Such situations demand ingenuity. There are as many solutions to such problems as there are individuals who may be called upon to solve them. As guides for action in such adverse situations, several substitutes for the wheeled litter carrier are described. These substitutes are not standard items of supply, nor is their standardization contemplated.

b. Cacolet.—(1) *Definition.*—A cacolet is a packsaddle fitted with a frame capable of supporting one or two litters or folding chairs. Its employment by the military, for transportation of sick and wounded, dates to the Crimean War, when it was utilized by the French Army.

(2) *Types.*—Numerous types have been developed and used with varying degrees of success. The following are examples possessing merit:

(a) *Carlisle cacolet* (figs. 109 and 110).—This cacolet, developed by the Medical Department Equipment Laboratory, Carlisle Barracks, Pa., consists of a folding metal frame fitted to a Phillips packsaddle, and, when open, will support two loaded litters, one on each side, the litters firmly secured to the frame by setscrew clamps.

(b) *Panama jungle cacolet* (fig. 111).—Devised by the medical service for the purpose of evacuating sick and wounded from the jungle, this type consists of a metal frame similar to the modified Stokes litter in appearance, over which metal bows have been securely fastened. In this, the patient rests on a waterproof kapok pad. The whole device is firmly bolted to a Phillips packsaddle, protection to the patient on the trail thus being rendered from all directions. The weight of the entire apparatus is 57 pounds and the apparatus, loaded, may be floated across unfordable streams.

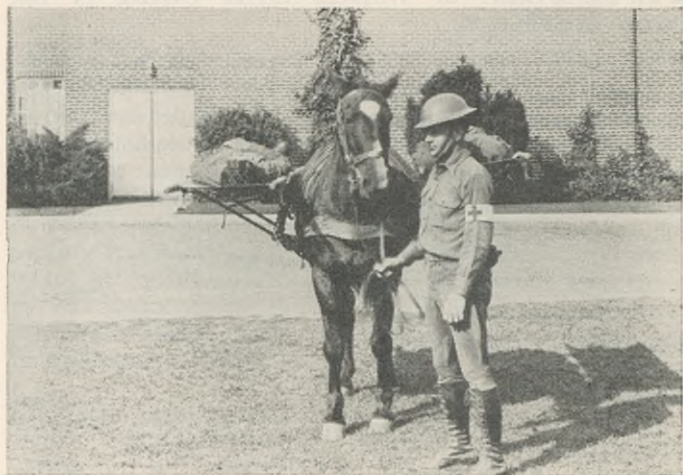

FIGURE 109.—Cacolet, Carlisle, front view.

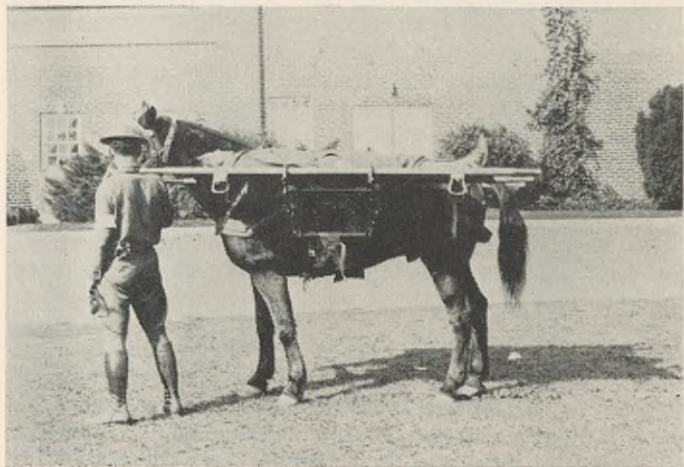

FIGURE 110.—Cacolet, Carlisle, side view.

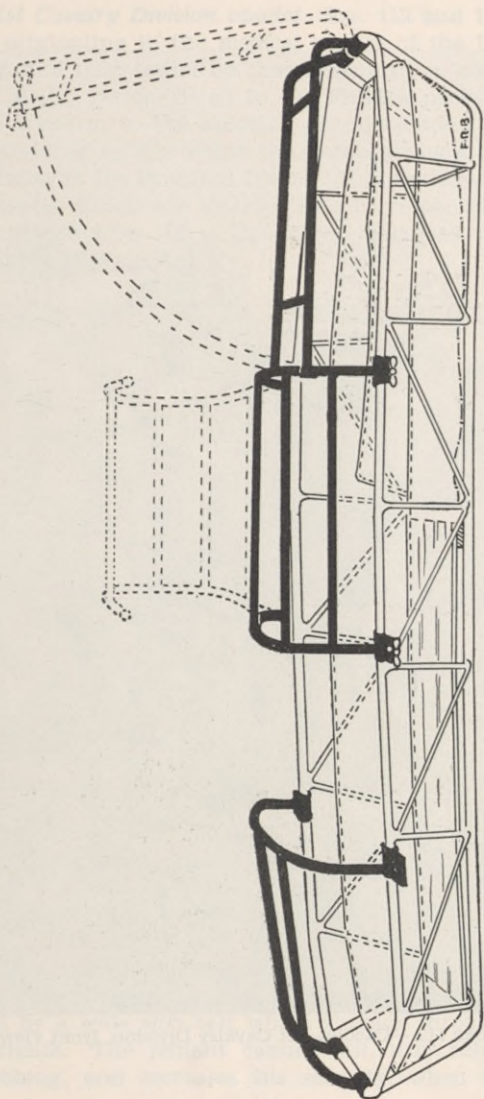

FIGURE 111.—Sketch of Panama jungle cacolet.

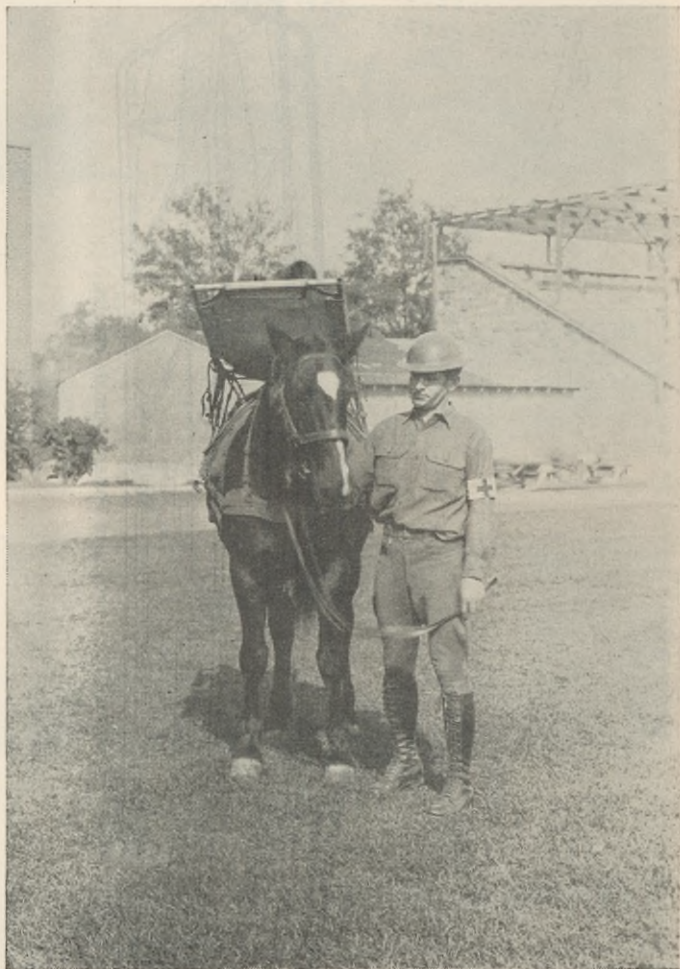

FIGURE 112.—Cacolet, 1st Cavalry Division, front view.

(c) *1st Cavalry Division cacolet* (figs. 112 and 113).—This device, originating in the medical service of the 1st Cavalry Division and field tested by that organization, consists of a tubular metal frame, fitted to the Phillips packsaddle, and bent to conform to the animal's dorsal contour. A canvas bed is stretched tightly within the frame, giving it an appearance similar to the Bradford frame. It is equipped with four metal braces which are inserted into corresponding keepers on the packsaddle. It is light, well balanced, and fairly comfortable.



FIGURE 113.—Cacolet, 1st Cavalry Division, side view.

(d) *Hamilton chair cacolet* (fig. 114).—The Hamilton chair is applicable to the evacuation of conscious or semi-conscious patients, especially from mountainous terrain. It consists of a regulation riding saddle equipped with four sockets, two each front and back, into which, when desired, four metal uprights are placed. The front uprights are joined at their upper ends by a transverse bar, and the whole surrounded by a wide web belt which threads through slots in the uprights. The patient cannot fall, may relax against the webbing, and increases his security, when fully con-

scious, by grasping or leaning against the transverse bar. When not in use, the superstructure occupies relatively little space on the top load of the medical pack.

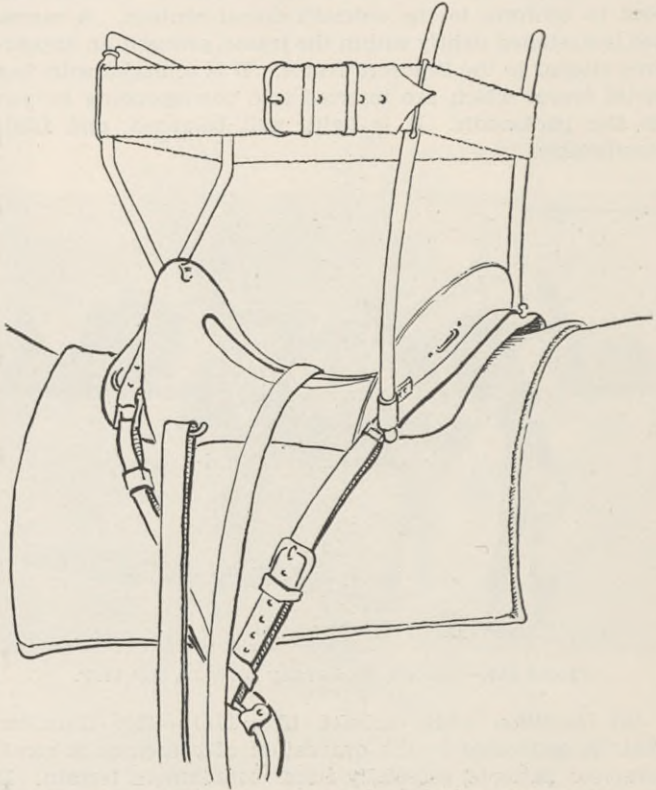

FIGURE 114.—Sketch of Hamilton chair cacolet.

c. Travois, or travail.—(1) *Definition.*—The travois is a contrivance for transportation of sick and wounded, consisting of two long poles lashed at one end to each side of a horse or similar animal, the other ends trailing the ground. Hurdles are lashed across these poles to receive the load.

(2) *Improvisation of a travois* (fig. 115).—A travois may be improvised by cutting poles about 16 feet long and 2 inches in diameter at the small end. These poles are laid parallel to each other, large ends to the front and $2\frac{1}{2}$ feet apart, the small ends 3 feet apart with one of the latter projecting some



FIGURE 115.—Sketch of one-horse travois.

8 or 10 inches beyond the other to impart a rocking rather than a jolting motion to the load. The poles are connected by a crossbar about 6 feet from the front ends and another about 6 feet back of the first, each notched at the ends and securely lashed to appropriate notches in the long poles. Be-

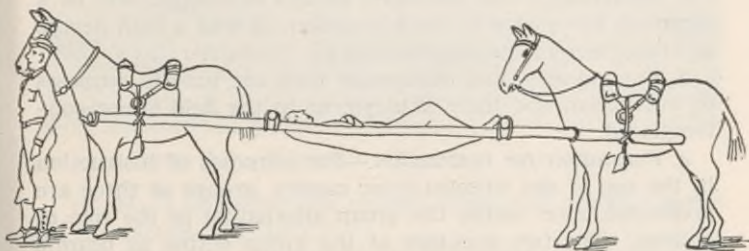

FIGURE 116.—Sketch of 2-horse travois.

tween the crosspieces, the litter bed, 6 feet long, is filled in with canvas, blanket, or similar material, securely fastened to the poles and crossbars. In lieu of canvas or blanket, rope, a lariat, or rawhide strips may be stretched obliquely from pole to pole, in many turns, crossing each other to form the basis for a light mattress or improvised bed. A

litter or cot may be fastened between the poles for the same purpose. The front ends of the poles are securely fastened to the saddle of the animal, and joined around the animal's chest by means of a breast strap. On the march, bearers should be ready to lift the rear end of the travois when passing obstacles, streams, or when going up hill.

(3) *Two-horse travois* (fig. 116).—A further development of the original travois is in current use by the British medical service. The rear ends of the poles, instead of being allowed to drag, are lashed to the saddle of a second horse, following the first in tandem.

SECTION II

INSTRUCTION IN THE USE OF THE WHEELED LITTER CARRIER

■ 29. GENERAL.—*a. Purpose.*—The purpose of this section is to furnish a guide for instruction in the use of the wheeled litter carrier and thereby standardize and accelerate such training.

b. Scope.—It includes instruction in opening, closing, loading, and unloading of the carrier.

c. Objectives.—The objectives of this instruction will be a thorough knowledge of the mechanism of, and a high degree of proficiency in the employment of, the carrier.

d. Commands.—Any commands used are for the purposes of instruction and their employment in the field is not contemplated.

e. Formation for instruction.—For purposes of instruction in the use of the wheeled litter carrier, groups of three are preferable, men within the group alternating in the role of patient. The two members of the group acting as bearers are designated Nos. 1 and 2, No. 1 being in charge.

■ 30. TO OPEN AND CLOSE CARRIER.—*a. To open carrier.*—The carrier being on the ground, folded, to open, the commands are: 1. OPEN, 2. CARRIER. At the command CARRIER, the following steps of procedure are executed:

(1) Both bearers proceed by the most direct route to the folded carrier and take positions, one on each side adjacent

the wheels, No. 1 on the side to which the support stand is attached (fig. 117).

(2) Bearers stoop, grasp the litter pole racks (fig. 118) and, in unison, lift them until the wheels are in upright position (fig. 119).

(3) Maintaining the upright position of his respective wheel with his left hand, each bearer, with his right, pushes lock into position and secures it by tightening the setscrew (fig. 120).

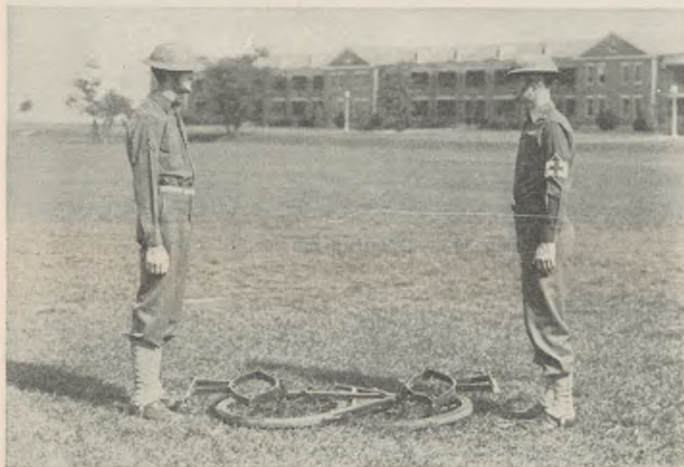

FIGURE 117.—Bearers in position to open carrier.

(4) No. 1 unlatches the support stand and brings it down to the vertical (fig. 121).

(5) Both bearers loosen the screw brackets and swing them laterally, leaving the litter pole racks open to receive the litter, then they resume their positions at the wheels, facing the carrier (fig. 122).

b. To close carrier.—The carrier being open and unloaded, to close carrier, the commands are: 1. CLOSE, 2. CARRIER. At the command CARRIER, bearers move directly to positions at wheels, if not already there, and proceed to perform in reverse order, the same steps as required to open it (*a* above).

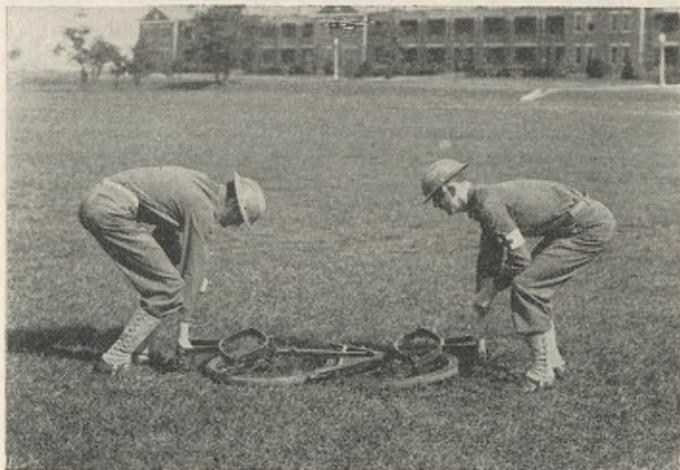

FIGURE 118.—Opening carrier, first step.



FIGURE 119.—Opening carrier, second step.



FIGURE 120.—Opening carrier, third step.



FIGURE 121.—Opening carrier, fourth step.

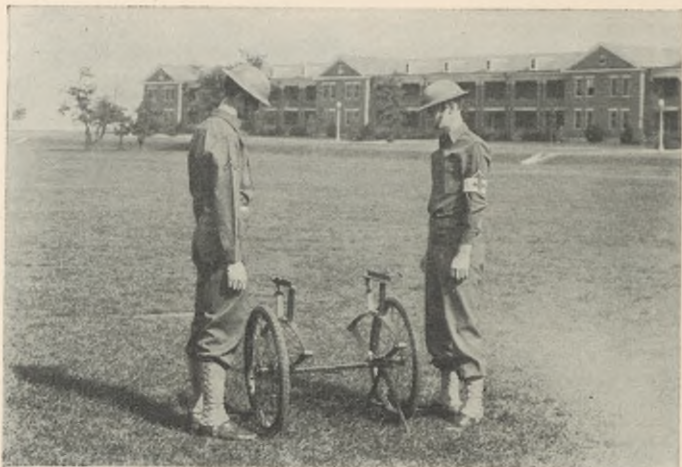

FIGURE 122.—Opening of carrier completed.

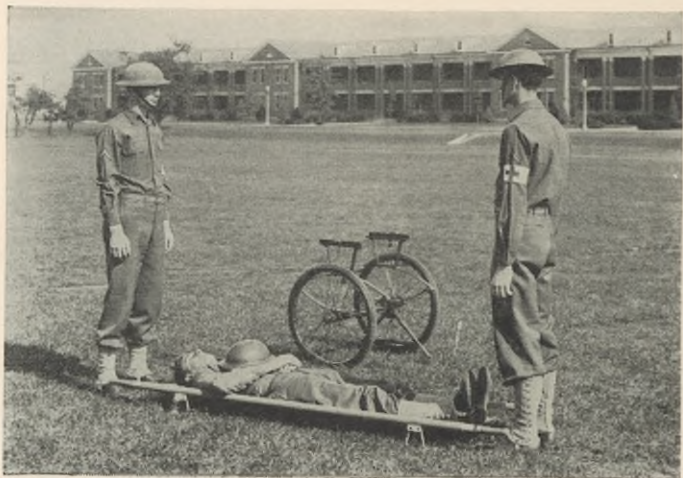

FIGURE 123.—Bearers at FACING PATIENT, LITTER, POSTS.

Screw clamps are moved centrally and tightened; No. 1 lifts the support stand and latches it; both unfasten wheel locks, and, in unison, allow wheels to fold at the axle joints. When the carrier has been completely closed, bearers resume upright position.

■ 31. TO LOAD AND UNLOAD CARRIER.—*a. Posts at loaded litter.*—The carrier being open and conveniently located, to place bearers in position to proceed with the loading, the commands are: 1. FACING PATIENT, 2. LITTER, 3. POSTS. At the command POSTS, bearers move by the most direct route and take positions between the handles of the litter, Nos. 1 and 2 facing the patient's head and feet, respectively (fig. 123).

b. To load carrier.—The litter being loaded, the bearers at posts, and the command PREPARE TO LIFT, LIFT, having been given and executed, to load carrier the commands are: 1. LOAD, 2. CARRIER. At the command CARRIER, the procedure is as follows:

(1) Bearers carry the litter and place it on the carrier, the poles lying firmly in the racks and the litter well balanced on the carrier (fig. 124).

(2) No. 1 remains in position and steadies the litter while No. 2 locks poles into racks by adjusting and tightening the screw brackets (fig. 125).

(3) No. 2 folds and latches the support stand (fig. 126) and resumes his position at the patient's feet, facing front (fig. 127).

c. To unload carrier.—The carrier being loaded and the bearers being in position for movement, to unload carrier, the commands are: 1. UNLOAD, 2. CARRIER. At the command CARRIER, No. 1 stands fast and steadies the litter while No. 2 loosens the screw brackets, moves them laterally, unlatches and lowers the support stand, and resumes his post, facing the patient's feet. Without further command, bearers lift litter, move it clear of the carrier, and perform further actions at the command of the instructor or No. 1 bearer.

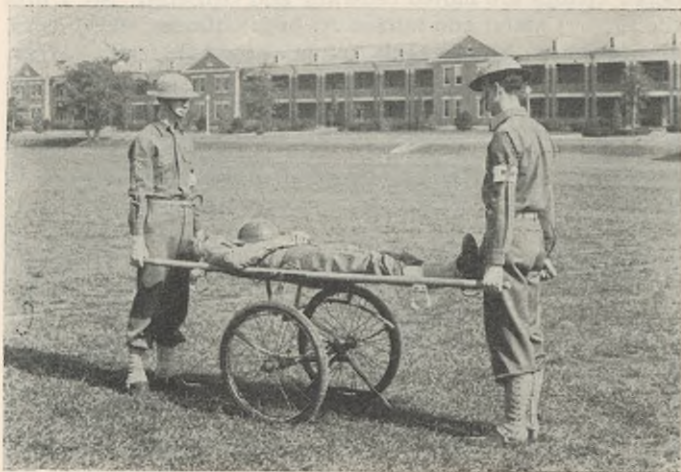

FIGURE 124.—Placing loaded litter on carrier.

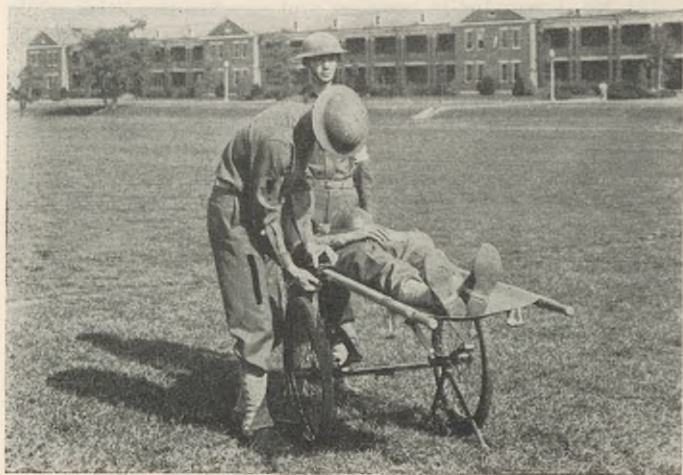

FIGURE 125.—No. 2 locking poles to racks.



FIGURE 126.—No. 2 latching support stand.

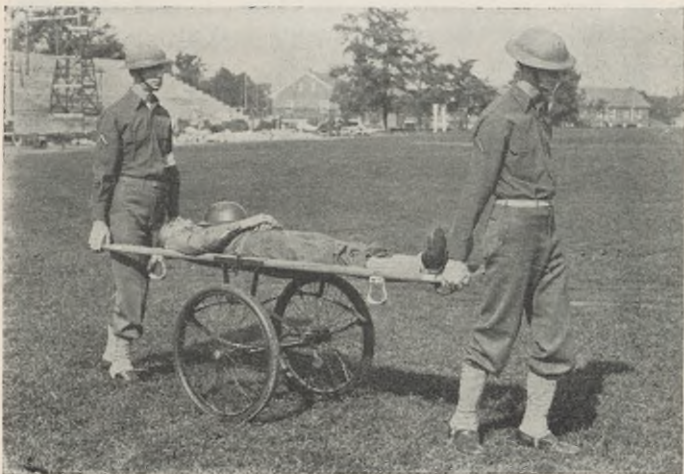

FIGURE 127.—Carrier loaded, bearers ready to move out.

CHAPTER 5

AMBULANCE TRANSPORTATION OF THE SICK AND WOUNDED

	Paragraphs
SECTION I. General	32-36
II. Instruction in ambulance loading and unloading.	37-41

SECTION I

GENERAL

■ 32. GENERAL.—*a. Definition.*—An ambulance is a wheeled vehicle designed and employed for the conveyance of sick and wounded.

b. Ambulances employed by Medical Department.—(1) *Motor.*—Figure 128 shows an ambulance station in France, 1918, with World War motor ambulances.

(a) *Metropolitan ambulance* (figs. 129 and 130).—The large metropolitan ambulance, designed for and equipped with large, single, basket-type, wheeled litter, is used at general hospitals in the zone of the interior and at the larger Air Corps posts.

(b) *Ambulance, field* (figs. 131 and 132).—The field ambulance, motor, used at the majority of posts and stations and in the field is a 1½-ton, 2-wheel drive, panel body vehicle with a patient capacity of four litter, or eight sitting, or various combinations of litter and sitting cases. It is satisfactory as a road ambulance but its value is limited for cross-country employment.

(c) *Ambulance, field, cross country* (figs. 133 and 134).—For front line and cross country use, the 4-wheel drive, ½-ton motor ambulance is the preferred vehicle. (See par. 33 for detailed description.)

(2) *Animal-drawn.*—(a) *Ambulance, 4-animal* (figs. 135 and 136).—The 4-animal ambulance, model of 1909, is available for employment in situations requiring an animal-drawn vehicle but not demanding any considerable speed. This ambulance is satisfactory for employment with foot troops on the march.

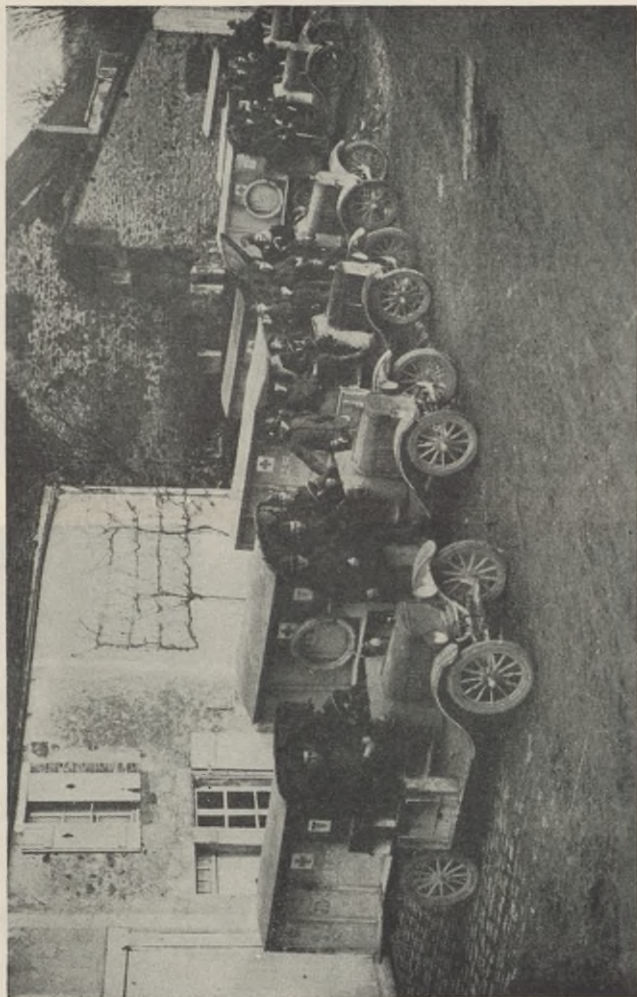

FIGURE 128.—An ambulance station of the 42d Division, Rolampont, February 10, 1918.



FIGURE 129.—Metropolitan ambulance, exterior view.

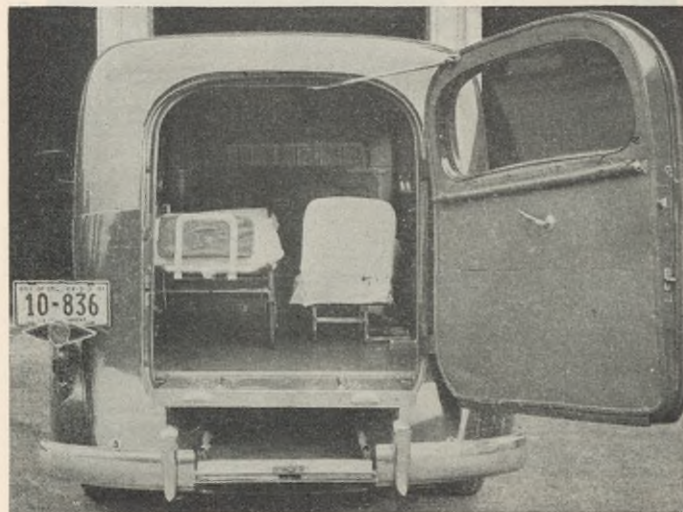

FIGURE 130.—Metropolitan ambulance, interior view.

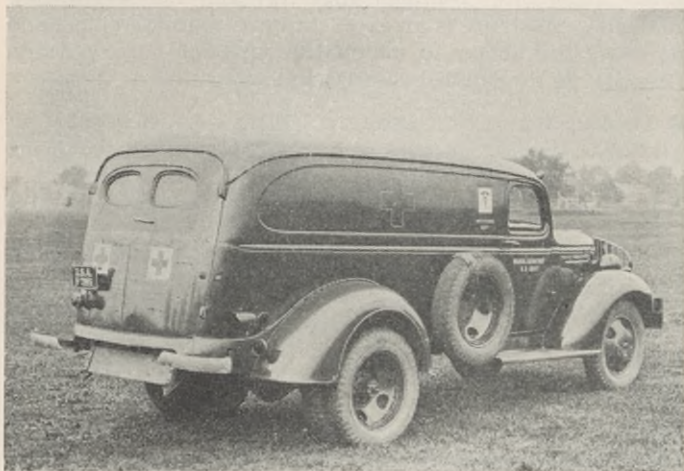

FIGURE 131.—Ambulance, field, motor (exterior).

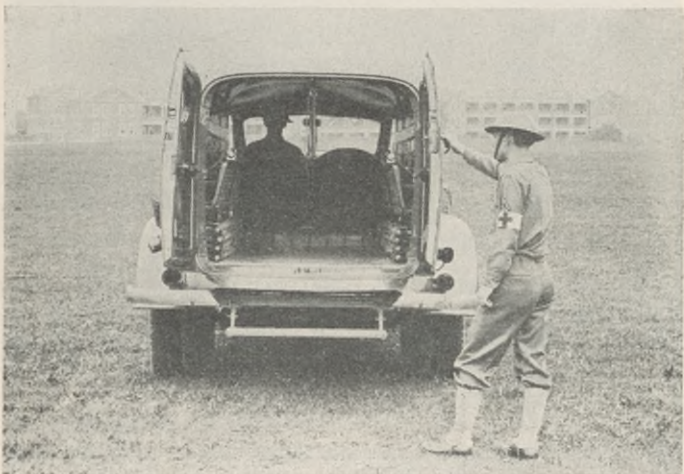

FIGURE 132.—Ambulance, field, motor (interior).

(b) *Ambulance, 2-animal* (figs. 137 and 138).—The new 2-animal ambulance is an excellent cross country vehicle and possesses the ability to match the speed of horse cavalry. (See par. 34 for detailed description.)

■ 33. AMBULANCE, MOTOR, FIELD.—a. *General*.—(1) *Status*.—Two distinct types of field ambulance are now being employed (see par. 32). The new cross country field ambulances are allocated to field units, such as armored, cavalry



FIGURE 133.—Ambulance, field, motor, cross country (exterior view).

and infantry divisions. The former field ambulance will continue to be used wherever necessary and feasible. In time, if experience proves the lighter cross country vehicle capable of universal use, it may supplant the 1½-ton field ambulance entirely.

(2) *Definitions*.—(a) *Panel body*.—The term “panel body” used in connection with an ambulance implies that the light, commercial type, delivery truck body has been utilized without structural change.

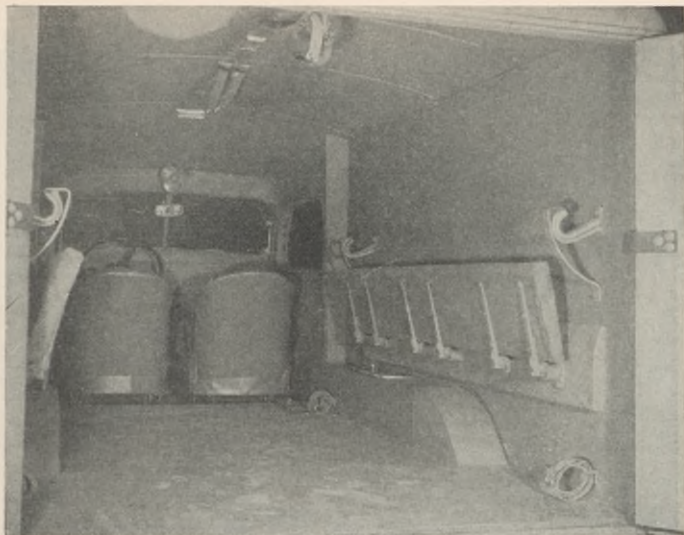

FIGURE 134.—Ambulance, field, motor, cross country (interior view).



FIGURE 135.—Ambulance, animal-drawn (old type), exterior.

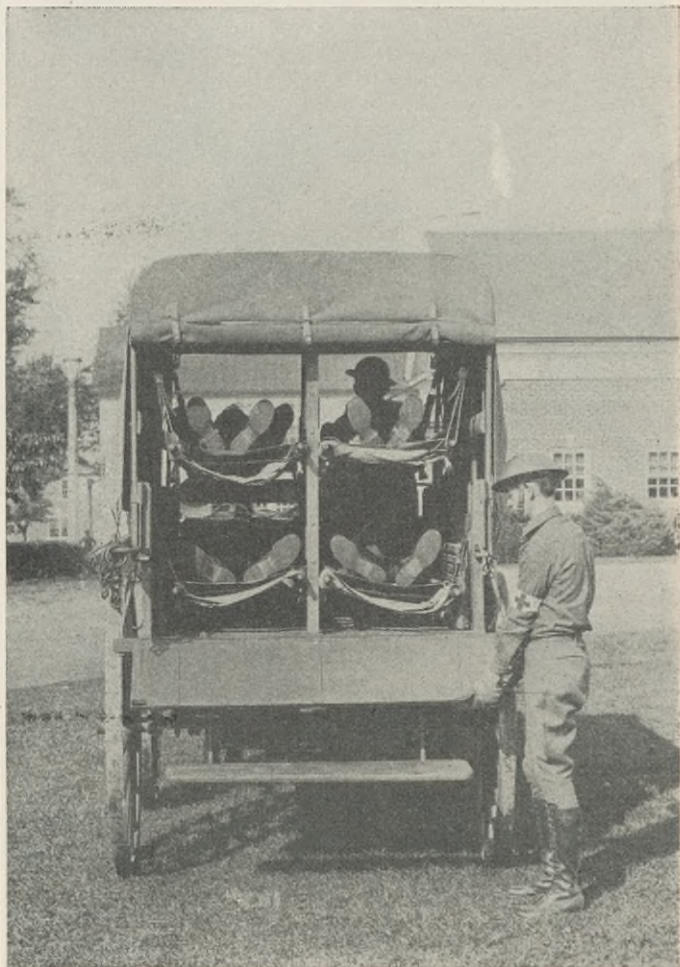

FIGURE 136.—Ambulance, animal-drawn (old type), interior.

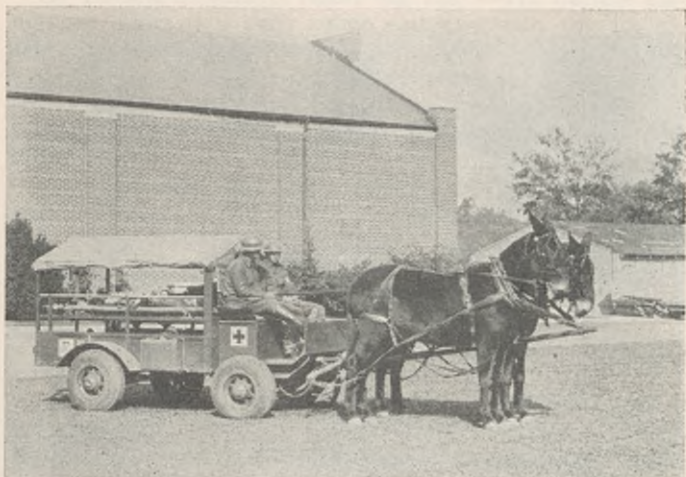

FIGURE 137.—Ambulance, animal-drawn, (new type) exterior.



FIGURE 138.—Ambulance, animal-drawn, (new type) interior.

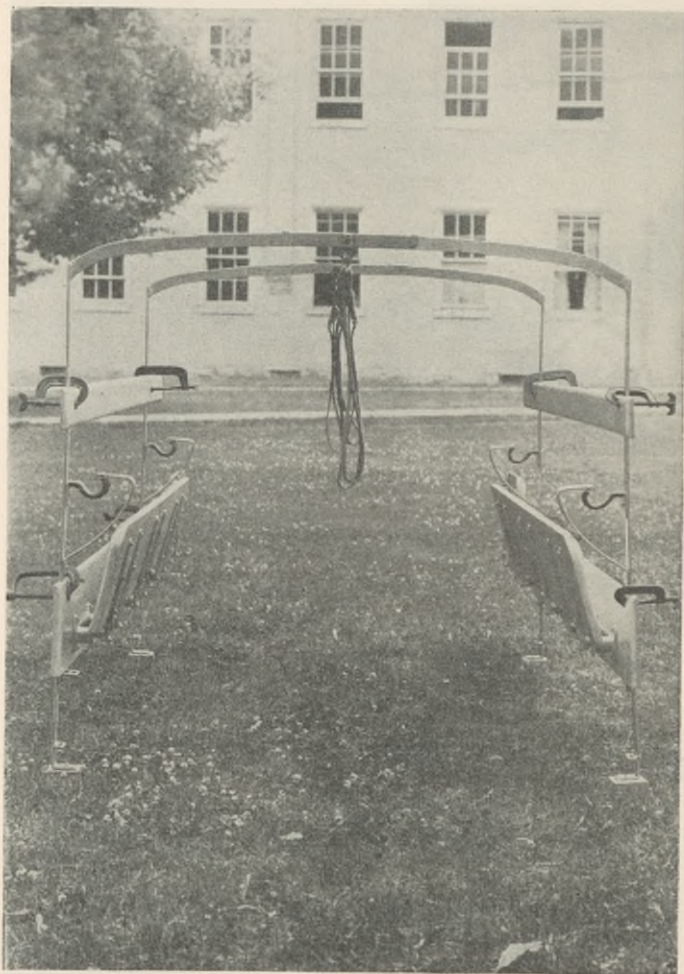

FIGURE 139.—Insert, ambulance, Carlisle.

(b) *Carlisle ambulance insert* (fig. 139).—The Carlisle ambulance insert is a light frame equipped with two folding seats and brackets and hangers for supporting loaded litters. This insert converts the panel body truck into a field ambulance. As implied by the designation, it was developed at the Medical Department Experimental Laboratory, Carlisle Barracks, Pa.

(3) *Ambulance, field, requirements of.*—(a) *Capacity.*—Vehicle should be capable of transporting seven sitting or four litter cases with their impediments, a maximum load of approximately 1,500 pounds.

(b) *Speed.*—The ability to travel 50 miles per hour on suitable roads is desirable.

(c) *Cruising radius.*—Fuel capacity should be sufficient to carry the vehicle at least 200 miles.

(d) *Ability to cross rough terrain.*—A reasonable ability to overcome such obstacles as steep inclines, shallow ditches, cultivated ground, loose boulders, muddy or swamp ground, sand, or snow is mandatory.

(e) *Ease in driving.*—Ease in driving will result in economy of personnel in a sustained action.

(f) *Riding comfort.*—The vehicle, to best serve not only the patient's comfort but also his general condition, should possess pneumatic tires, a satisfactory type spring, and facilities for heating, lighting, and ventilating the interior.

(g) *Safety factors.*—The safety of operating and passenger personnel should be considered in the selection of such equipment as brakes, lights, horns, shatter-proof glass, and similar items.

b. *Cross country motor field ambulance* (fig. 133).—The new cross country ambulance more nearly meets the ideal requirements than does any other similar vehicle developed thus far.

(1) *Description.*—Any measurements given are maximum or minimum specifications and are subject to slight variations by the manufacturer.

(a) *Chassis.*

1. *General.*— $\frac{1}{2}$ -ton, truck type, 123-inch wheel base, 4-wheel drive, 47 $\frac{1}{2}$ inches between wheel housings.
2. *Wheels.*—Four, 16-inch, steel construction.

3. *Tires*.—7.50, pneumatic, low pressure, all weather, non-skid.
4. *Engine*.—6-cylinder.
5. *Brakes*.—4-wheel, hydraulic.
6. *Shock absorbers*.—Double action.
7. *Gas tank*.—Capacity 25 gallons.

(b) *Body*.

1. *General*.—Panel, steel, insulated; height of floor from ground, 32 inches maximum loaded; height (over all), 86 $\frac{3}{4}$ inches (approximate).
2. *Patient compartment*.—Inside measurement, 98 inches long, 60 inches wide, 53 $\frac{3}{4}$ inches high.
3. *Rear door*.—Measurements, 56 inches wide, 46 inches high.
4. *Seats for personnel*.—Two, single, separate; one for chauffeur, non-folding, leather covered, capable of being displaced forward 13 inches when loading; one for ambulance orderly, folding.
5. *Glass*.—Safety plate, shatter-proof.
6. *Seats and litter supports* (see fig. 134).—Lateral, longitudinal, folding seats for sitting patients, padded with sponge rubber, duck covered; lateral brackets and centrally suspended slings for supporting upper tier of litters; lower tier of litters fixed by lateral straps near floor. It will be noted that, in this ambulance, the insert has been eliminated and seats, brackets, and supports are all bolted firmly to the body.
7. *Ventilation*.—Double system, front and rear, primary and auxiliary, positive exhaust.
8. *Heater*.—Type capable of heating interior to 70° F., outside temperature being 0° F.

(2) *Capabilities*.—(a) *Speed*.—Governed at 50 miles per hour.

(b) *Cruising range*.—Estimated 250 miles.

(c) *Patient capacity*.—Four litter, seven sitting, or two litter and four sitting cases.

c. *Personnel*.—Two men, a chauffeur and an ambulance orderly, are assigned to each motor ambulance. The former is responsible for the vehicle at all times. He makes minor

repairs and is responsible for reporting major defects to his section leader or, if the latter is not available, to the unit transportation sergeant or mechanic. The ambulance orderly acts as assistant driver, prepares the ambulance for loading and unloading, prepares it for departure after loading and unloading, and renders necessary first-aid and care to patients being transported.

■ 34. AMBULANCE, ANIMAL-DRAWN.—*a. Status.*—To a considerable extent, the cross country motor field ambulance has supplanted the animal-drawn ambulance. However, situations will arise wherein the latter will be employed. The new type ambulance is preferable to the old model 1909, but many of the latter are still in service and in depot storage, and will be utilized until they reach a stage of unserviceability.

b. Ambulance, animal-drawn, requirements.—To be of practical value, the animal-drawn ambulance should meet the following general requirements:

(1) *Weight.*—The weight should be such as to permit its being drawn by two animals at the average speed of horse cavalry.

(2) *Height.*—A low vehicle decreases the tendency to overturn on rough terrain and the target presented by its silhouette.

(3) *Cross country employment.*—The general construction of the vehicle and its equipment should be sufficiently durable to permit prolonged usage over rough terrain.

(4) *Comfort and safety.*—Such equipment as tires, brakes, springs, and lights should be of such character as to reasonably insure the comfort and safety of patients and operating personnel.

(5) *Trailer employment.*—Vehicle should be capable of conversion to trailer for use with light motor vehicles.

c. Ambulance, animal-drawn, new type.—(1) *General.*—The new type animal-drawn ambulance was designed at the Medical Department Equipment Laboratory, Carlisle Barracks, Pa., and has had field testing over a period of several years. Its capabilities approach the ideal requirements of an animal-drawn ambulance.

(2) *Description* (fig. 137).—(a) *General*.—The weight of the vehicle is approximately 1,000 pounds, and height over all, 80 inches. Even in the field, but two animals are needed for propulsion.

(b) *Chassis*.—The frame is metal with automotive type front axle and transverse, semielliptic springs, front and rear. The wheels are five in number (one spare), automotive type, of metal construction, and equipped with low pressure pneumatic tires, size 7.50 by 16. The brakes are front wheel, internal expanding, mechanical type, operated by pressure on a foot pedal located centrally in front of the driver's seat.

(c) *Body*.—The body bed is of wood, reinforced with strap iron. The frame of the superstructure is of wood and tubular duraluminum, the cover being of waterproof, olive-drab canvas. The inside measurements are length, 90 inches; width, 47½ inches; and height, 57 inches. A central, wooden, longitudinal seat may be elevated or lowered. In its normal position, lowered, it will accommodate five sitting cases, and when raised becomes the central support for the upper tier of litters. Lateral support for the upper tier is furnished by two longitudinal troughs, attached to the frame on each side, in which the litter stirrups slide during loading and unloading. The lower litters rest on the floor where their exact fit precludes the necessity for other means of fixation. The body is designed to accommodate a maximum load of four litter or five sitting cases. However, with two litter cases, three sitting cases may be transported although they will be uncomfortable for the reason that half the seat will be occupied by the upper litter. Immediately in front of the body, a transverse seat, accommodating two men, rests on the jockey box, the latter being sufficiently large to hold necessary tools and the personal equipment of operating personnel.

d. *Personnel*.—The animal-drawn ambulance requires two men, a driver who is responsible for the vehicle and animals, and an attendant who acts as assistant driver, assists in loading and unloading, and renders necessary care to the patients en route.

■ 35. EMPLOYMENT OF AMBULANCES IN THE FIELD.—See FM 8-10.

■ 36. TRAINING OF AMBULANCE PERSONNEL.—*a. Motor ambulance.*—See FM 25-10, Motor Transport.

b. Animal-drawn ambulance.—See FM 25-5, Animal Transport.

SECTION II

INSTRUCTION IN AMBULANCE LOADING AND UNLOADING

■ 37. GENERAL.—*a. Purpose.*—The purpose of this section is to furnish guides for training enlisted personnel in proper methods of loading and unloading the ambulance.

b. Demonstration.—Utilization of demonstration will enhance the efficacy of this instruction.

c. Commands.—Any commands used are for purposes of instruction, and their use in the field is not contemplated. These commands are limited in number and cover the general acts performed in loading and unloading the ambulance. Details of the actual performance of these acts will vary slightly, depending on the number of bearers, presence or absence of ambulance orderly or assistant driver, and type ambulance employed.

d. General rules.—(1) *Berths and order of loading.*—The four longitudinal spaces formed within an ambulance, when loaded litters are in place, are known as berths and are designated right (left) upper (lower). Four litter cases are loaded in the following order: right upper, left upper, right lower, and left lower. When loading two litter and one or more sitting cases, the right berths are utilized for the loaded litters, the order being right upper; and right lower. When loading two litter and no sitting cases, the lower berths are utilized, the order being right lower; and left lower.

(2) *Order of unloading.*—Berths are unloaded in reverse order to that by which they are loaded.

(3) *Patients with splints.*—Patients with cumbersome splints will be loaded in lower berths, when the situation permits.

(4) *Position of patient in ambulance.*—Unless otherwise indicated, litter cases will be loaded head first. Prior to loading, litter will be grounded three paces to the rear of, and with the patient's head toward, the ambulance.

e. Preparation for instruction.—(1) *Ambulances.*—The number of ambulances to be utilized will depend on the size of the unit to be instructed and the availability of ambulances. Each ambulance should have its full complement of personnel, that is, driver or chauffeur, and assistant driver or ambulance orderly.

(2) *Formation.*—Unit to be instructed will be formed in litter squads and two squads will be detailed to each ambulance, if available. Personnel will alternate, by litter squads, in the role of bearers and patients.

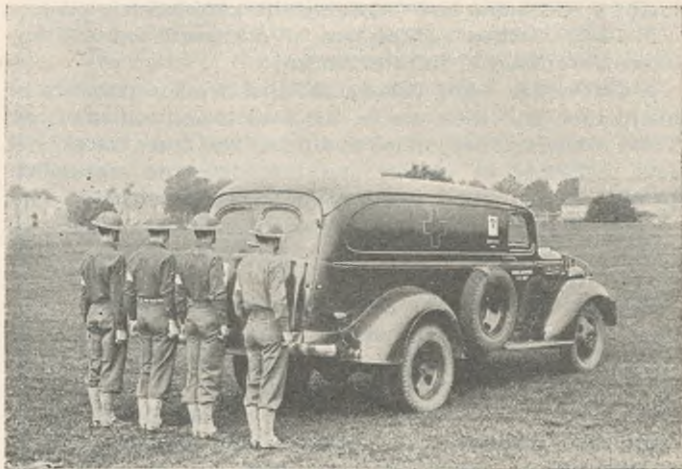

FIGURE 140.—Litter squad at AMBULANCE, POSTS.

■ 38. **AMBULANCE POSTS.**—The squad being in the vicinity of the ambulance, to assemble prior to loading or unloading, the commands are: 1. AMBULANCE, 2. POSTS. At the command POSTS, the members of the squad move rapidly by the shortest practicable route to the ambulance, and aline themselves in numerical sequence from left to right, one pace in rear of the vehicle (fig. 140). This is the invariable position of the squad at AMBULANCE, POSTS.

■ 39. **AMBULANCE LOADING.**—The squad being at AMBULANCE, POSTS and the ambulance being prepared to receive patient

(fig. 141), to load ambulance, the commands are: 1. RIGHT (LEFT) UPPER (LOWER) BERTH, PREPARE TO LOAD, 2. LOAD. The procedure is as follows:

a. At the first command, bearers take position as follows: No. 2, at foot of litter facing patient, stoops and grasps handles; Nos. 1 and 3, one on each side of litter facing patient's shoulders, grasp the right and left poles, respectively (fig. 142).

b. At the command LOAD, the litter is lifted by Nos. 1, 2, and 3 and advanced into the berth designated in the preparatory command (fig. 143).



FIGURE 141.—Ambulance ready to receive patients.

c. At the same command, the ambulance orderly or assistant driver, from the front of the ambulance, assists in advancing the litter within the ambulance, and secures front handles in brackets, straps, hooks, or other device present.

d. The rear handles are secured by Nos. 1 and 3 (fig. 144).

e. No. 4, in the meantime, renders aid as indicated or, in the absence of the ambulance orderly, performs the orderly's normal duties.

f. Following the loading, preparation of the ambulance for departure, such as lowering curtains and closing doors or



FIGURE 142.—Loading ambulance, first step.



FIGURE 143.—Loading ambulance, second step.



FIGURE 144.—Rear handles being secured.



FIGURE 145.—Ambulance loaded, being prepared to move.

tail gate, is accomplished by the ambulance orderly or, in his absence, by No. 4 (fig. 145).

g. When loading has been completed, squad resumes position at **AMBULANCE, POSTS** without command.

■ **40. TO UNLOAD AMBULANCE.**—The squad being at **AMBULANCE POSTS**, and the ambulance being prepared for unloading, to unload ambulance, the commands are: 1. **RIGHT (LEFT) UPPER (LOWER) BERTH, PREPARE TO UNLOAD**, 2. **UNLOAD**. The procedure is as follows:

a. At the first command, Nos. 1, 2, and 3 step forward and arrange themselves numerically, from right to left, at the foot of the litter; and the ambulance orderly (or No. 4 in his absence) takes position within the ambulance, at the head of the litter.

b. At the command **UNLOAD**, No. 2 grasps the projecting handles and draws out the litter, assisted by Nos. 1 and 3, who, facing inward, support the poles.

c. An upper berth being unloaded, Nos. 1 and 3 free the rear, the ambulance orderly the front, handles, then all three lower the litter to the floor and the squad proceeds as in unloading a lower berth.

d. When clear of the ambulance, the litter, carefully supported in horizontal position, is grounded three paces in rear of the vehicle. Members of the squad resume their positions at litter posts without command.

■ **41. LOADING AND UNLOADING BY LIMITED PERSONNEL.**—Situations will arise wherein loading and unloading of ambulances must be performed by less than the normal complement of personnel. The absence of No. 4 bearer entails no substitution. In the absence of No. 4 and the ambulance orderly or assistant driver, the chauffeur or driver will perform their duties. In the absence of Nos. 3 and 4, the ambulance orderly will substitute for No. 3, and the chauffeur, or driver, will assist from the front. In the absence of Nos. 3, 4, and the ambulance orderly, the ambulance will be prepared by No. 1, after which the litter will be placed in lower berth by Nos. 1 and 2. An upper berth being loaded, Nos. 1 and 2 will perform the duties of Nos. 1 and 3, the chauffeur or driver assisting from the front. Unloading is performed in like manner but in reverse order.

CHAPTER 6

AIR TRANSPORTATION OF THE SICK AND WOUNDED

■ 42. GENERAL.—*a. Increased difficulty of evacuation.*—Motorization, mechanization, and aviation have increased the tempo of modern warfare. Concepts of distances have shrunk and, frequently, lines of communication are long and insecure. For evacuation to keep apace, every available means must be employed. Evacuation by air will be utilized whenever feasible.

b. Present status of evacuation by air.—The value and practicability of evacuating certain types of cases by air during times of peace have been demonstrated fully in our Army. Recently, certain powers have demonstrated its value in time of war, under favorable conditions. The most important factor in the successful employment of such means is *air superiority*.

c. Results of evacuation by air.—Actual application of the airplane to the medical task of evacuation accomplishes the following:

(1) With a maximum degree of rapidity and comfort and a minimum degree of deleterious effect, certain types of seriously injured patients are transported from combat zone to general hospital, either in the communications zone or zone of the interior, where early definitive treatment can be instituted.

(2) The psychological effect upon the remaining effectives results in a marked elevation of the morale of the entire fighting force.

■ 43. ADVANTAGES OF EVACUATION BY AIR.—*a. Speed.*—The attainable speed of air transport will decrease evacuation time and reduce the number of fatalities incident to transportation, providing that, under medical supervision, cases for evacuation are properly selected prior to, and properly cared for during, the actual movement.

b. Comfort of patients.—In general, no other mode of transport approaches the degree of comfort offered the patient by the airplane. The discomfort, and actual danger involved in

certain types of cases, may be circumvented by low-altitude flying and the administration of oxygen en route.

c. Safety.—The airplane, if air superiority is maintained, represents the safest means of transport and, if cases for movement be selected properly, the safest method of transportation. Safety guaranteed by agreement between nations will be of questionable value.

d. Morale.—Successful evacuation by air will increase the morale of combat troops.

e. Treatment en route.—In aircraft designed or converted for transportation of casualties, considerable treatment can be administered en route. Examples: application and readjustment of splints; administration of stimulants, sedatives, sera, and other medication; arrest of hemorrhage; treatment of shock; and most important of all, administration of oxygen.

NOTE.—All aircraft intended for purposes of evacuation will be equipped with apparatus for the administration of oxygen.

f. Medical supplies.—Aircraft utilized for evacuation may be employed, in their forward movement, for delivery of emergency medical supplies to medical units functioning in the combat zone.

g. Redistribution of the medical task.—Institution of evacuation by air within the combat zone will transfer the heavier treatment load from mobile installations of the combat zone to fixed installations of the communications zone or zone of the interior.

■ 44. AREAS OF EMPLOYMENT.—*a. Theater of operations.*—Within the theater of operations, two echelons of evacuation by airplane ambulance are contemplated:

(1) *Within the combat zone.*—Small landing fields will be located as near division clearing stations as possible. (The location of potential fields will be considered by clearing elements in the establishment of their installations.) From these fields, selected cases (par. 45) from clearing stations will be evacuated by light ambulance transport or shuttle planes to larger fields in the rear portion of the army area.

(2) *From combat to communications zone.*—At landing fields in the army area will be collected the cases brought by

plane from more forward areas, plus selected cases from evacuation hospitals, from which collection centers they will be transported by heavy ambulance transport airplanes to general hospitals in the communications zone or, in some situations, to those in the zone of the interior.

b. Zone of the interior.—(1) *From theater of operations.*—If the theater of operations and zone of the interior are contiguous, or separated by a small body of water, large ambulance airplanes may evacuate sick and wounded from either the combat or communications zone of the theater directly to the zone of the interior. In this event, incoming ambulance airplanes may proceed to one conveniently located central field or to one of several fields located in the vicinity of general hospitals.

(2) *Within zone of the interior.*—In the event that casualties from the theater of operations are brought to large reception centers by airplane or other means of transport, ambulance airplanes may then be utilized for distribution of such cases to various general hospitals within the zone of the interior. Furthermore, casualties occurring within the zone of the interior itself, either because of the peculiar nature of the case or the isolated character of its geographical location, may be evacuated by airplane ambulance to civilian or military medical centers.

■ 45. TYPE PATIENT FOR EVACUATION BY AIR.—*a. General.*—All cases do not respond favorably to air transportation, hence proper selection of cases by medical personnel is the foremost consideration in the application of the airplane to the task of evacuation. Care must also be taken to avoid evacuating cases to either the communications zone or zone of the interior, which normally would not be moved farther to the rear than the evacuation hospital.

b. Cases adapted to air transportation.—Evacuation by air is intended primarily for seriously sick and wounded cases. The following types of cases are examples of those especially adapted to such means of transport: severe facial wounds; brain injuries; eye injuries; shattering wounds of the spinal column, pelvis, or extremities; severe wounds of the chest or abdomen providing such cases are recent, have *not* been operated upon, and have not suffered severe hemorrhage;

and such medical cases as severe dysentery, typhoid, and similar conditions.

c. Contra-indications to evacuation by air.—For physiological reasons, presence of the following conditions should contra-indicate evacuation by air: severe shock; recent major operative procedure; severe anemia due to hemorrhage; cases of, or complicated by, pneumonia; cases complicated by restricted breathing capacity as a result of hemothorax, pneumothorax, pulmonary hemorrhage, or marked elevation of the diaphragm due to severe intra-abdominal pressure, gaseous or otherwise.

d. Evacuation by air in emergencies.—Air transport being available and evacuation by air being feasible, all cases, regardless of type, will be evacuated by such means if by so doing the abandonment of patients or their capture by the enemy will be averted.

■ 46. AIRPLANE AMBULANCES.—*a. Types.*—Depending upon their two principal missions, the following general types of aircraft will be employed as airplane ambulances:

(1) A light transport airplane capable of transporting, besides the operating personnel, 2 to 4 litter cases and 1 medical officer or enlisted attendant.

(2) A heavy transport airplane (see fig. 146, exterior view, Douglas C-39 ambulance airplane) capable of carrying, besides the operating personnel, from 9 to 16 litter cases, a medical officer, and an enlisted attendant (fig. 147, interior view, same airplane showing nine modified Stokes litters ready to receive patients). The former will be utilized in the combat zone as a shuttle airplane to transport cases from loading points in the vicinity of clearing stations to loading centers in the army area. The latter, or heavy airplane, will evacuate cases from the rear of the combat zone to the communications zone, or to the zone of the interior, as the situation permits. Large airplanes may be employed to evacuate cases from installations of the communications zone to the zone of the interior.

b. Requirements.—The general type, number of engines, structural specifications, safety appliances, and flying instruments of airplane ambulances come within the purview of the Air Corps. However, from the point of view of the



FIGURE 146.—Douglas C-39, exterior.

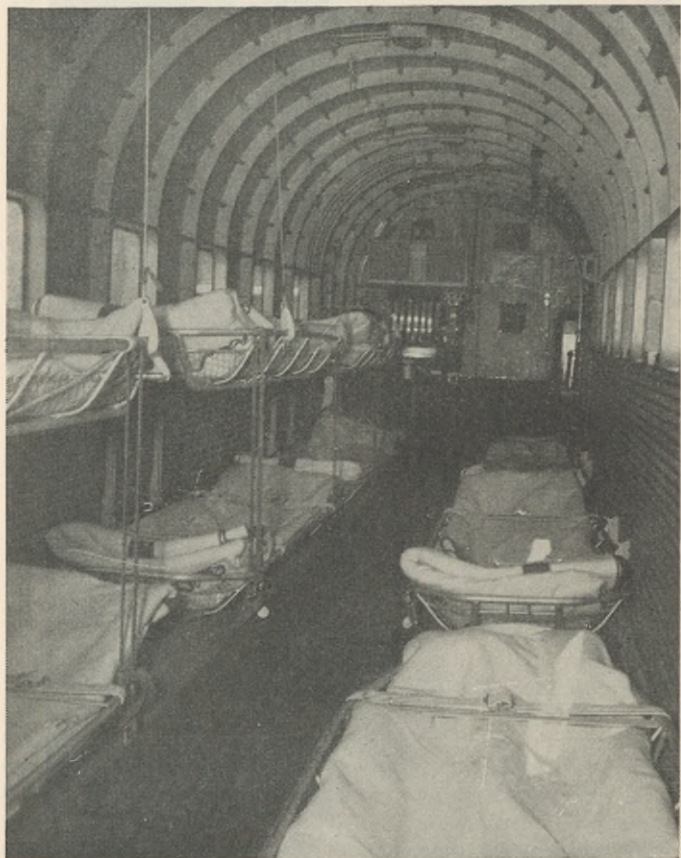

FIGURE 147.—Douglas C-39, interior.

arm or service charged with care and treatment of patients being transported, the following requirements are considered desirable:

(1) *For all airplane ambulances.*—(a) *Cabins.*—Regardless of size, cabins should be equipped with heating and ventilating systems, doors of sufficient size to permit free entry of a loaded litter, and racks or supports for the accommodation of standard Medical Department litters (see par. 13). Utilization of a standard litter precludes unnecessary movement of the patient incident to his evacuation.

(b) *Radio.*—For liaison with ground personnel at loading and unloading points, inclusion of the radio in the equipment of airplane ambulances is considered of vital necessity.

(c) *Medical equipment.*—All airplane ambulances will be equipped with apparatus for the administration of oxygen and those items of medical supply (litters, blankets, and splints) necessary to accomplish the usual property exchange. Other medical equipment may be added as indicated.

(2) *For shuttle or light transport airplane.*—Those ambulance airplanes plying within the combat zone should accommodate, in addition to the operating personnel, from 2 to 4 litter cases and 1 medical officer or enlisted attendant. Gasoline for more than 100 miles will seldom be required.

(3) *For heavy transport plane.*—Those airplanes furnishing the second echelon of airplane ambulance evacuation service should accommodate from 9 to 16 litter cases and 2 medical attendants (1 officer and 1 enlisted) in addition to the operating personnel. Gasoline for more than 500 miles will seldom be required.

c. *Sources.*—Aircraft for airplane ambulance use may be obtained direct from manufacturers or by conversion of commercial or military transport planes. The latter will require but minor structural changes. (Fig. 148 shows the interior of a standard commercial passenger airplane converted for the accommodation of 12 litter cases. Note that litters are firmly attached to floor and litter racks and that patients are securely strapped to the litters.)

■ 47. UNITS FOR EVACUATION BY AIR.—a. *Air Corps.*—(1) *Designation.*—Air Corps units, for the purpose of transporting



FIGURE 148.—Interior of commercial plane, converted (looking forward).

sick and wounded, are designated Air Corps airplane ambulance groups, the number of such groups to coincide with the number of field armies.

(2) *Organization.*—The Airplane ambulance group is organized as follows:

(a) A headquarters and headquarters squadron similar to the corresponding unit of the transport group (see T/O1-352) but with three light ambulance transports substituted for the three combat planes.

(b) Two squadrons of 12 heavy ambulance transports each, similar to the squadron, transport (see T/O 1-355).

(c) One squadron of 18 light ambulance transports.

(3) *Personnel.*—The airplane ambulance group is an Air Corps unit and all personnel, other than medical (b below), will be furnished by the Air Corps.

(4) *Employment.*—Typically, the squadron of light transports will operate a shuttle system of evacuation between the division and army areas of the combat zone, the two squadrons of heavy transports between the army area of the combat zone and the communications zone or zone of the interior.

b. Medical Department.—(1) *Designation.*—The medical unit, known as the medical battalion, airplane ambulance, is organized to function with the Air Corps airplane ambulance group.

(2) *Organization.*—The medical battalion, airplane ambulance, is organized as follows:

(a) A headquarters and headquarters detachment, corresponding to the headquarters and headquarters squadron of the group.

(b) Two medical companies, airplane ambulance (heavy transport).

(c) One medical company, airplane ambulance (light transport).

(3) *Personnel.*—Personnel for the medical battalion, airplane ambulance, will be furnished by the Medical Department from personnel attached to the Air Corps for duty. The unit will contain sufficient personnel for its own administration (except that messing will be with Air Corps or army units), the medical care of the companion Air Corps unit, and the care of patients during their actual transportation

(one medical officer and one enlisted attendant per heavy transport and one medical officer or an enlisted attendant per light transport).

■ 48. CONTROL OF AIRPLANE AMBULANCE UNITS.—Air Corps Airplane ambulance groups and their companion medical battalions, airplane ambulance, are under control of GHQ and will be attached to field armies as need for their employment arises. While so attached, they will be under control of the army commander. The chief surgeon of the field force and the army surgeon will make recommendations to the force and army commander, respectively, for their actual employment. The responsibility for ambulance transports will rest with the Air Corps at all times; that for care and treatment of patients transported, with the Medical Department.

CHAPTER 7

RAIL TRANSPORTATION OF THE SICK AND WOUNDED

■ 49. GENERAL.—*a. When employed.*—Railway transportation for the sick and wounded will be utilized whenever feasible, unless other available means be preferable.

b. Where employed.—Normally, the extreme limits of rail evacuation are a railhead in the army area and a general hospital in the zone of the interior. Within these limits, other means such as airplanes and ships may be employed as adjuncts to the rail transport. Under exceptional circumstances, wherein the military situation has become stabilized and railways have been constructed for the supply of troops in forward areas of the combat zone, evacuation of divisions may be feasible by rail transportation.

c. Means of transport.—For evacuation of army and rearward installations, hospital trains will be utilized. For evacuation of division areas, any available rail transport will be utilized.

■ 50. HOSPITAL TRAINS.—*a. Status.*—Hospital trains are mobile agencies of the Medical Department by means of which evacuation of sick and wounded is accomplished. The Medical Department is charged with furnishing personnel and medical equipment for such trains, and with their general administration. As railway units, they are operated and maintained mechanically under direction of the Corps of Engineers in the theater of operations.

b. Classification.—(1) *Type hospital train.*—See paragraph 53.

(2) *Improvised hospital train.*—See paragraph 51.

■ 51. IMPROVISED HOSPITAL TRAIN.—*a. Composition.*—The composition of improvised hospital trains will depend on the number and type of patients to be transported, and rolling stock available. Cars suitable for employment are—

(1) *Standard Pullman sleepers.*—Standard Pullman sleepers are capable of transporting from 24 to 36 litter cases, include compartments for quartering duty nurses, and require

no structural changes prior to employment. Integral berths may be utilized or hospital beds may be installed.

(2) *Tourist sleepers*.—Tourist sleepers may be utilized without structural changes. Their patient capacity is greater than that of standard sleepers, but they lack the comfort and privacy afforded by the latter. Hospital beds may be installed (fig. 149).

(3) *Standard chair cars*.—Standard chair cars may be utilized without structural change for the transportation of sitting cases. Their conversion for the accommodation of litter cases may be accomplished by removing the chairs and installing 2- or 3-tiered beds, such as the Glennan bunk (fig. 150). The Glennan bunk is 2-tiered and consists of a metal frame arranged for bolting to the floor and wall, which supports a mattress and springs of a hospital bed fitted with side hinges and straps. Figure 151 shows interior of car utilizing Glennan bunks. The upper tier may be used for a patient, or folded against the wall as a back rest for patients sitting on the lower tier.

(4) *Standard baggage cars*.—One standard baggage car for each improvised hospital train is desirable for the purpose of transporting the impedimenta of patients, the baggage of duty personnel, and surplus medical and other supplies. In the absence of more suitable cars, they may be converted for transportation of patients (see (3) above).

(5) *Hospital unit car*.—Each improvised train should include one hospital unit car (see par. 52).

b. Capacity.—The patient capacity will vary with the limitations imposed upon train length by the character of the road bed and the motive power. For economical operation, trains having a minimum capacity of 300 patients are desirable.

c. Personnel.—No definite allotment of Medical Department personnel for improvised hospital trains is possible. Sufficient officers and enlisted men will be furnished to insure proper care of the patients en route. The utilization of nurses on such trains is contemplated.

d. Where employed.—Improvised hospital trains will be employed routinely in the zone of the interior and in the theater of operations, whenever feasible, thus leaving the



FIGURE 149.—Interior of standard car showing beds installed.

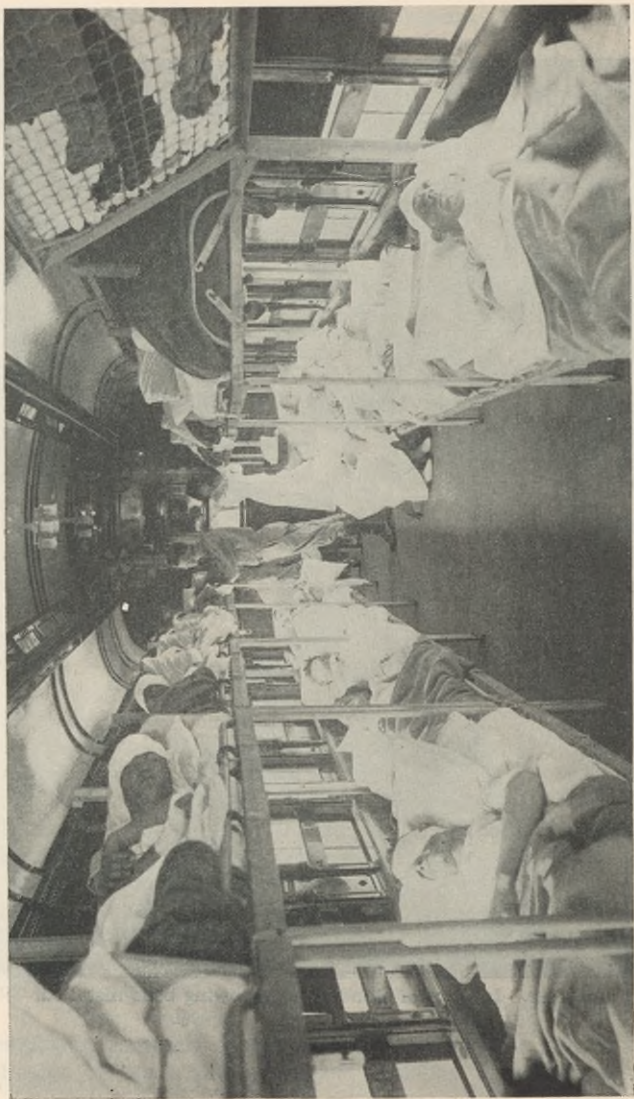

FIGURE 150.—Converted chair car with patients on tiered bunks.

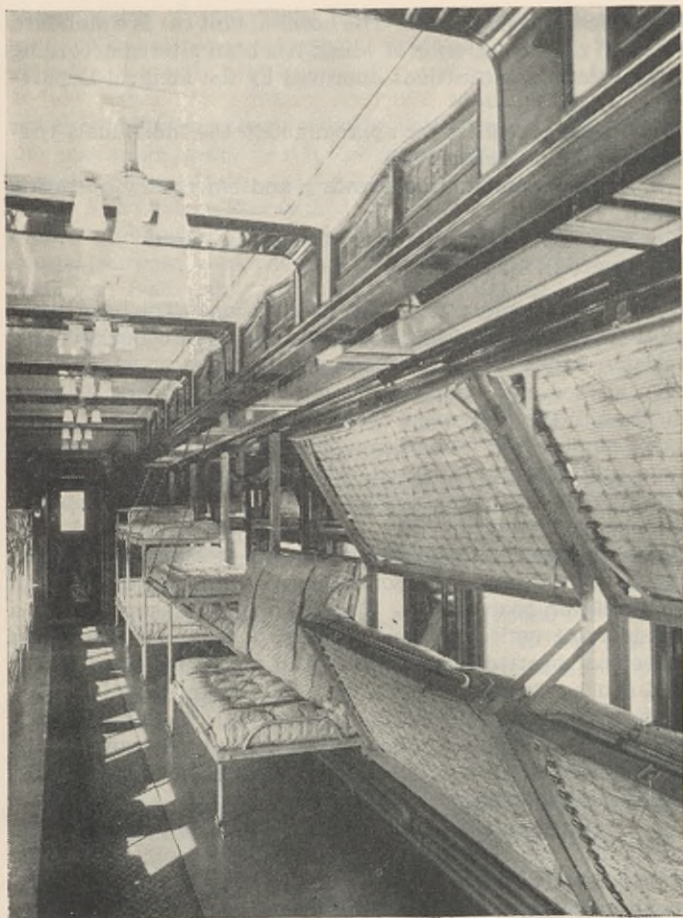

FIGURE 151.—Glennan bunks installed in standard car.

type hospital trains free for employment in those areas precluding the utilization of standard rolling stock.

■ 52. HOSPITAL UNIT CAR.—The hospital unit car is a standard Pullman car, the interior of which has been altered according to plans and specifications approved by the Medical Department to provide—

a. Cooking facilities for approximately 500 individuals (patients and duty personnel).

b. A small combination dressing and emergency operating room.

c. An office for the administration of the train.

d. Quarters for officers.

■ 53. TYPE HOSPITAL TRAIN.—a. *Orientation*.—The term "hospital train," unqualified, is applied to a train composed of a variable number of cars, the superstructures of which have been altered and equipped to serve some particular purpose incident to the movement of sick and wounded by rail. The exact number and type of cars will depend upon the mission, time and distance involved, where the train will operate, condition of track and roadbed, and type of engine to which attached. The term "type hospital train" is applied to a train composed of 16 ward, 1 kitchen, 1 dressing and operating, 1 utilities, and 3 personnel cars—a total of 22 cars, all of the 20-ton boxcar type. This train is self-sustaining for a considerable period of time (at least 3 days); is capable of traversing hurriedly constructed and poorly ballasted track; and can be drawn by the 30-ton, internal combustion locomotive operated by the Corps of Engineers. To permit standardization of supplies and personnel, the type train will be utilized whenever practicable, but may be altered to meet existing situations.

b. *Requirements*.—(1) *General*.—(a) *Composition*.—The composition should be such as to include facilities for the transporting, feeding, and rendering of proper care and treatment en route, to sick and wounded patients.

(b) *Patient capacity*.—There are too many influencing factors to permit the establishment of definite and inflexible figures for the patient capacity of hospital trains. Based upon the mission, type patient, limit as to number of cars, ward

car capacity, train facilities, and time and distance involved, the capacity of each train must be determined in such a manner as to insure economical operation. If the time involved is more than 24 hours, all patients must be regarded as litter cases. As a guiding principle, while the means need not exceed the task, ordinarily the patient capacity should be the maximum permitted by physical factors. For patient capacity of type train, see *e* below.

(*c*) *Flexibility*.—Economical operation of hospital trains requires flexibility and this is gained by the development of special purpose cars covering the more important general facilities. Such cars can be added or eliminated to meet the requirements of the particular mission.

(2) *Special requirements*.—(*a*) *Accessibility*.—All ward cars should possess side doors to permit free entry of loaded litters and end doors to permit the movement of litter cases between cars with train in motion. Fig. 152 shows side door loading of ward car during World War.

(*b*) *Beds*.—All cars destined to carry patients should be equipped with beds or bunks capable of conversion to accommodate either sitting or litter cases. Their arrangement should facilitate loading and the rendering of care and treatment to patients.

(*c*) *Supplies*.—There should be available space for storage of sufficient general and medical supplies for at least a 3-day period. Drinking water and emergency medical supplies should be available in all cars.

(*d*) *Heating*.—The heating system should be such as to insure the proper warmth of patients regardless of the presence, absence, or type of engine attached.

(*e*) *Lighting*.—The lighting system should be independent of the locomotive or, if dependence be placed in the locomotive, an auxiliary system should be available.

(*f*) *Sanitary arrangements*.—All cars should be capable of being thoroughly cleaned and fumigated when necessary. Adequate ventilating, toilet, and bathing facilities should be installed.

(*g*) *Personnel*.—Because of possible delay due to the military situation or damage to track or bridges, Medical Department personnel should be sufficient to render proper care and

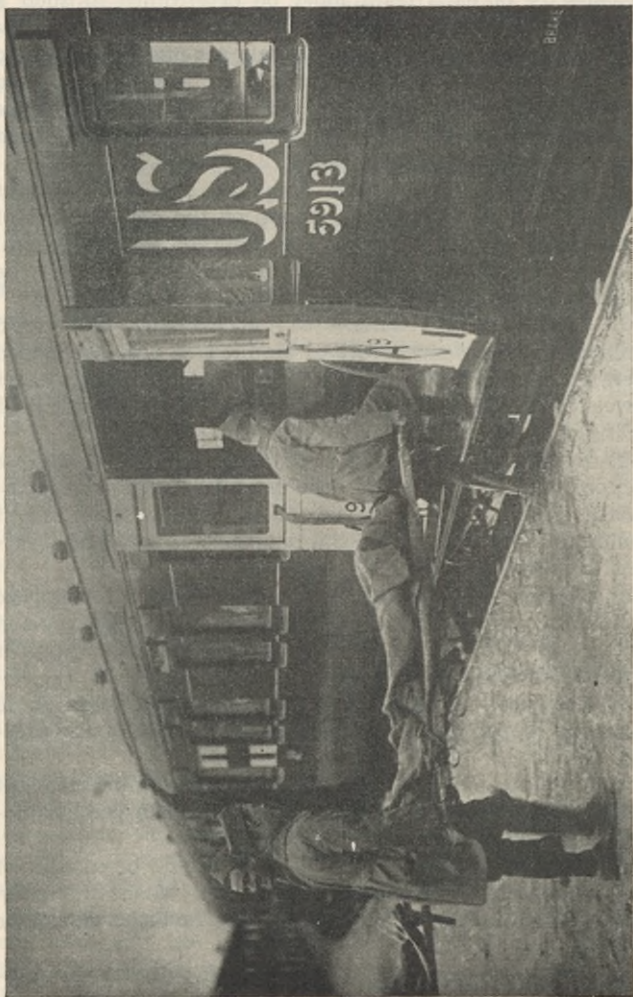

FIGURE 152.—Loading a hospital train.

treatment for a maximum patient load for a minimum of three days.

(h) *Miscellaneous.*—Cars should be equipped with safety devices to prevent accident or undue exposure of patients incident to movement between cars.

c. *Description of type hospital train.*—Figure 153 shows the exterior of a World War hospital train.

(1) *Composition.*—See *a* above. All cars have the undercarriage of the light, 20-ton boxcar, the superstructure altered to meet a special purpose. The weight of each loaded car is limited to 30 tons.

(2) *Description of special purpose cars.*—(a) *Ward car.*—Figure 154 shows the interior of a World War ward car. The ward car contains six tiered bunks of the Glennan, or similar type, arranged longitudinally, three on each side. Depending upon the type bunk and the time element, the patient capacity varies. If the bunks are 2-tiered and the trip of less than 24 hours duration, the maximum capacity is 12 litter cases or 6 litter and 24 sitting cases. If the bunks are 2-tiered and the trip of more than 24 hours duration, the maximum capacity is 12 cases, regardless of type. If the bunks are 3-tiered and the trip of less than 24 hours duration, the maximum capacity is 12 litter and 6 sitting cases (use of the upper tier for litter cases is not contemplated), or 30 sitting cases. If the bunks are 3-tiered and the trip of over 24 hours duration, the maximum capacity is 18 cases, regardless of type. Obviously, if the trip is of short duration, other combinations to meet existing situations are possible. Ward cars will have side and end doors of sufficient width to permit ingress and egress of loaded litters. Toilets and tanks for drinking water will be installed in each car. Heat and light will be furnished from central installations in the utilities car (see *e*) below).

(b) *Personnel car.*—Cars designed for duty personnel are of two types: For enlisted men—containing five 3-tier bunks, a toilet, a shower bath, and three storage lockers beneath each set of bunks; and for officers and noncommissioned officers—containing three compartments, one for an office, one for officers, and one for noncommissioned officers. The office contains a built-in table, seats, and a filing case. The com-

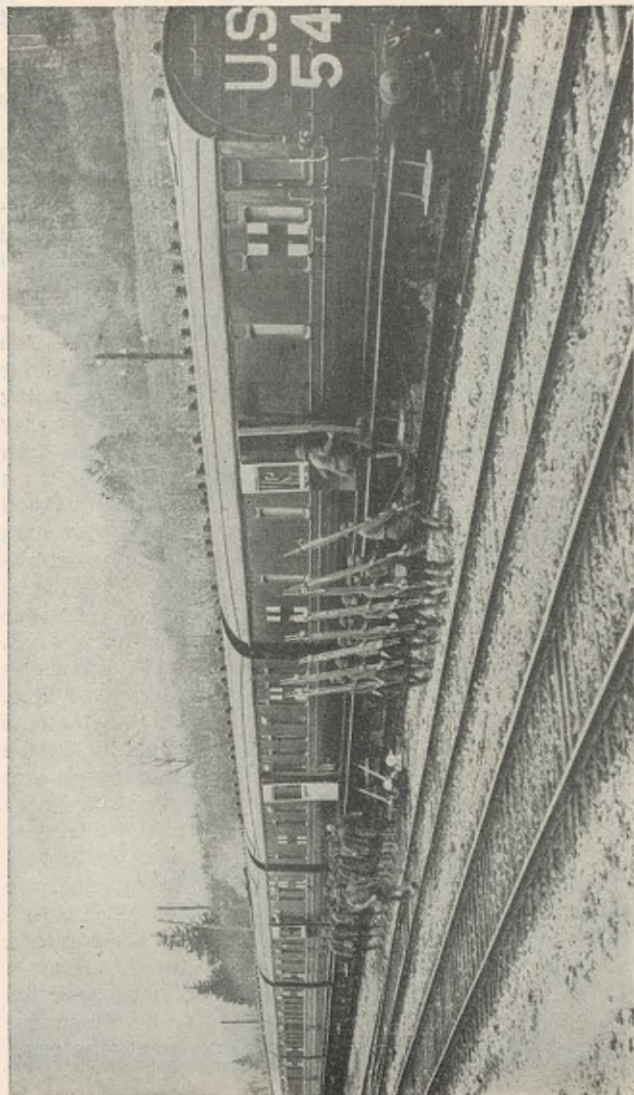

FIGURE 153.—Exterior of a hospital train.

partments for personnel contain two double-decked bunks, shower bath, toilet and lavatory, and storage lockers.

(c) *Dressing and operating car.*—Figures 155 and 156 are interior views of a World War dressing and operating car. This car contains a portable dressing and operating table, a double-decked bed for seriously ill patients, a dispensary table with closets and sink, toilet and lavatory, a floor sink, and necessary medical equipment, including a small sterilizer,

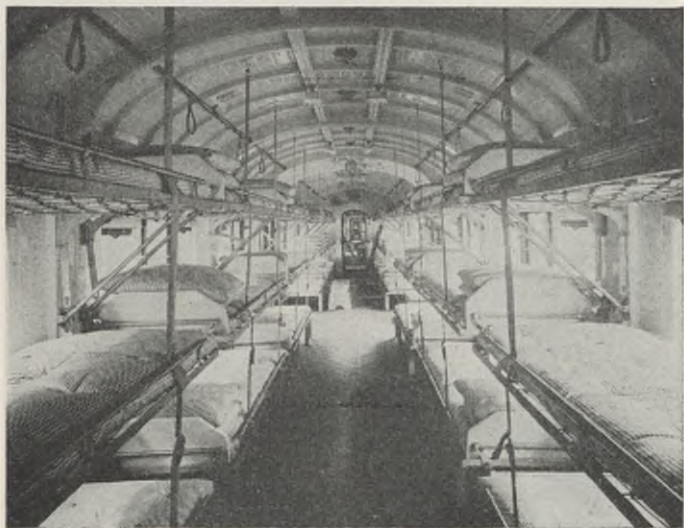

FIGURE 154.—Interior of a ward car, hospital train.

water boiler, instrument cabinet and table, and a small anesthesia apparatus. Other equipment and storage lockers will be installed as indicated.

(d) *Kitchen car.*—Figure 157 shows the interior of a World War kitchen car. This car will contain a range, coffee urn, steam table, refrigerator, water heater, dishwasher, cooking utensils, dishes, and storage lockers and closets for linen, silverware, dishes, nonperishable food, fuel, and other supplies.

(e) *Utilities car.*—This car will contain central lighting and heating units, facilities for storing fuel, and several shower baths for the use of assigned enlisted personnel.

d. *Personnel for type hospital train.*—In general, personnel for the type hospital train will be as follows: 3 or 4 medical officers; 4 noncommissioned officers (1st sergeant, mess, supply, and operating and dressing car); approximately 30 privates or privates first-class (cooks, clerk, pharmacist, orderlies, and medical and surgical technicians). A medical detachment

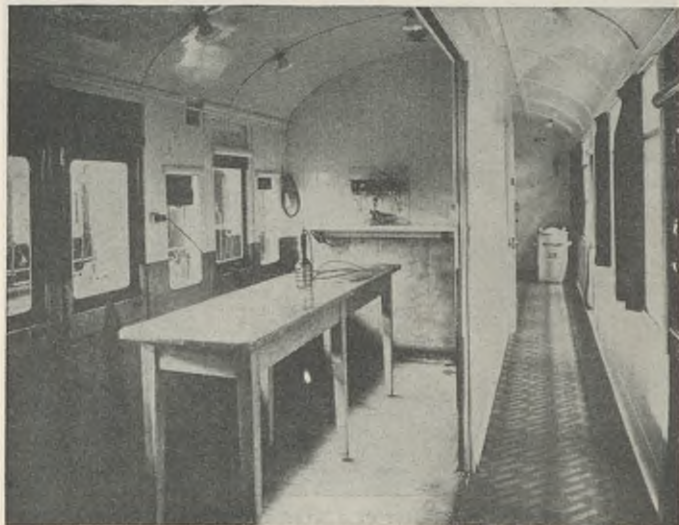

FIGURE 155.—Interior of dressing room, hospital train.

of this size can furnish proper care for the average patient load (see *e* below) and can be accommodated in three personnel cars (one of the officers and noncommissioned officers type, and two of the enlisted type). Employment of nurses in the type hospital train is not contemplated.

e. Patient capacity.—Depending upon the factors discussed in *c*(2) above, the patient capacity of a type train containing 16 ward cars will vary from 192 litter cases to 480 sitting cases, with the maximum actual load seldom reaching 300

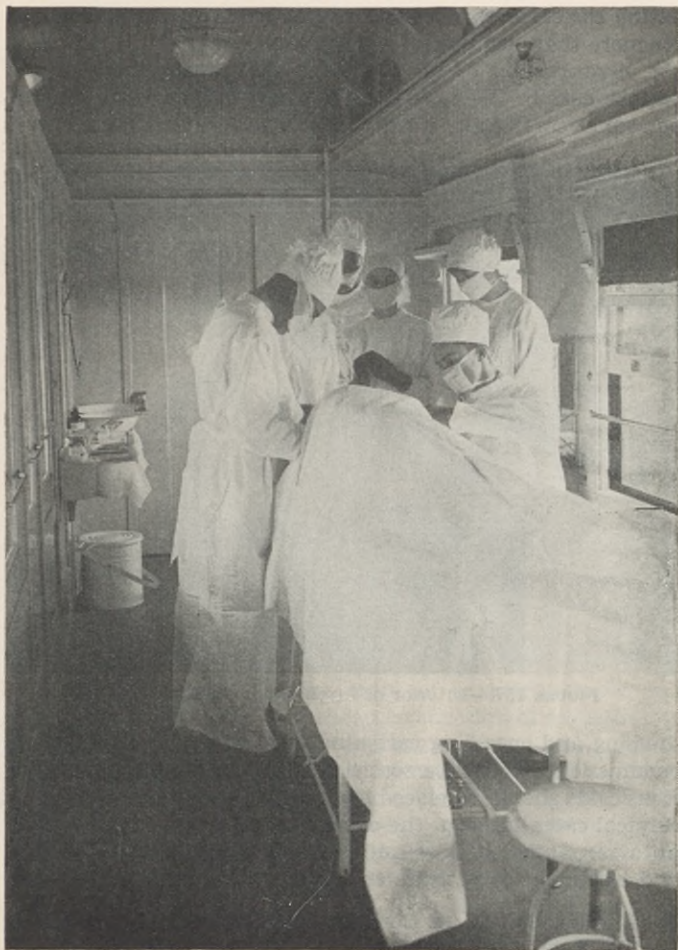

FIGURE 156.—Interior of operating room, hospital train.

patients. On the basis of World War 3:4 ratio, the average load will be approximately 268 patients, 116 litter and 152 sitting cases. Personnel and service facilities are inadequate for more than 400 patients.

f. Arrangement of cars.—A suggested arrangement of the various cars in the type hospital train follows: two enlisted personnel cars; eight ward cards; utilities car; kitchen car,

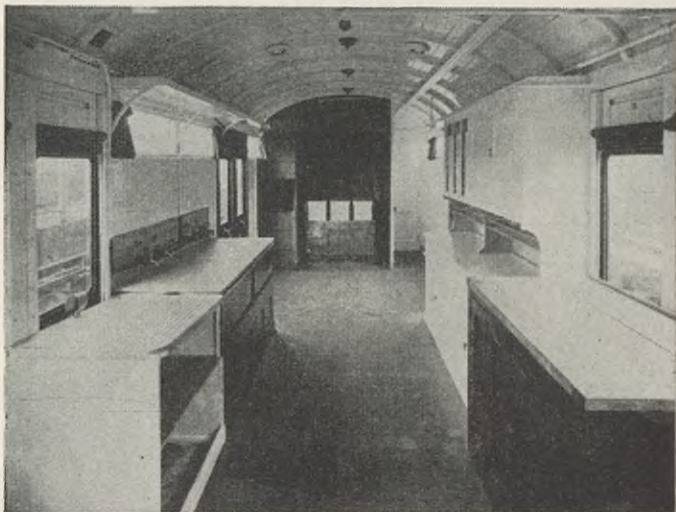

FIGURE 157.—Interior of kitchen car, hospital train.

dressing and operating car; nine ward cars; officer and non-commissioned officer personnel car. In loading, the more serious cases should be placed near the center of the train, with surgical cases adjacent the dressing and operating car. Such an arrangement of cars and patients will facilitate the care and treatment of patients en route.

■ 54. EMPLOYMENT AND CONTROL IN THEATER OF OPERATIONS.—
See FM 8-20.

CHAPTER 8

WATER TRANSPORTATION OF THE SICK AND WOUNDED

■ 55. GENERAL.—*a. Orientation.*—For transportation of the sick and wounded by water, any floating conveyance, depending upon its availability and feasibility, may be employed.

b. Application to military service.—Although seemingly a naval problem, nevertheless situations will arise wherein evacuation of the sick and wounded must be accomplished over bodies of water of varying size, without aid of the naval service. Under such conditions, a knowledge, though limited, of water transport, by the personnel of the Medical Department, becomes exceedingly important.

■ 56. WATER TRANSPORTATION, WHEN EMPLOYED.—*a. Oversea operations.*—Evacuation of the sick and wounded by means of water transport is mandatory if a military force is operating in a theater separated from the zone of the interior by a large body of water. Under these circumstances, one of two situations may obtain, separately, or one as an outgrowth of the other. These are—

- (1) Joint Army and Navy oversea operation.—See FM 8-25.
- (2) Separate Army oversea operation.

b. River crossings.—In the event of a river crossing and the establishment of a bridgehead, evacuation of casualties by small boats will be necessary pending sufficient development of the situation to permit bridge construction.

c. Airplane crashes.—Airplane crashes occurring over water demand rescue by boat in the absence of amphibian aircraft.

d. Waterways within theater of operations.—Rivers, lakes, canals, or other bodies of water within the theater of operations, especially if they tend to be more or less perpendicular to the front, may become if suitable craft is available an important link in the chain of evacuation.

■ 57. CLASSIFICATION OF WATER TRANSPORT.—*a. By type vessel.*—(1) *Ships.*—(a) *Fleet hospital ship* (fig. 158).—A fleet

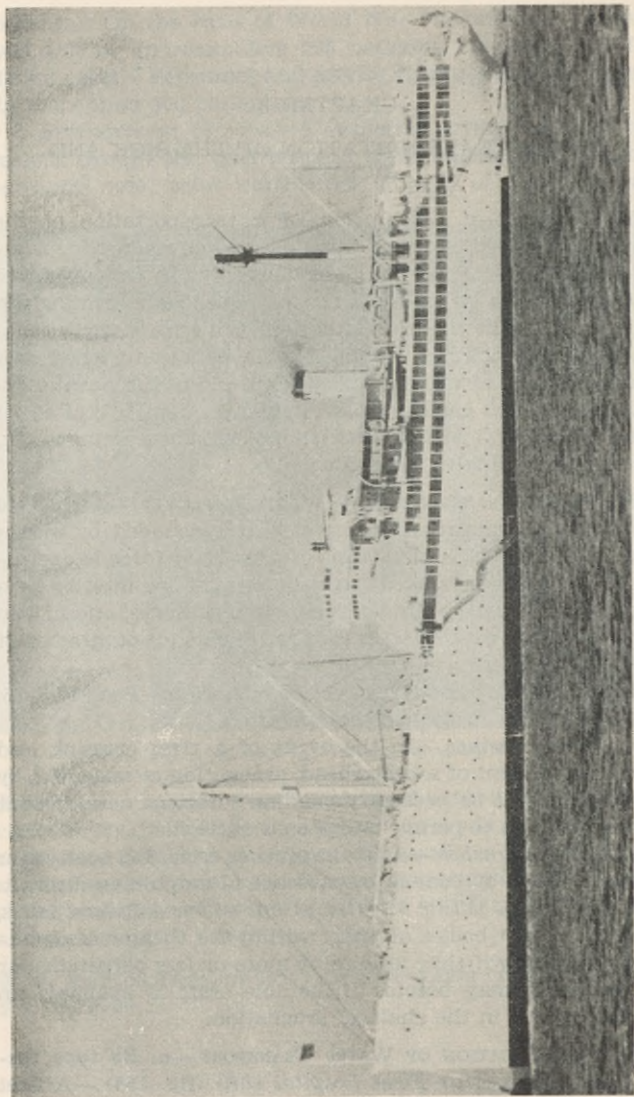

FIGURE 158.—Fleet hospital ship.

hospital ship, a naval institution, is a vessel designed and built to accompany the fleet and provide hospital facilities. It requires special construction and corresponds to a military general hospital in equipment and functions.

(b) *Hospital ship*.—Hospital ships are large vessels equipped to treat the sick and wounded. Usually such vessels are of the commercial type, passenger, cargo, or a combination of both, converted and equipped for this particular mission. If converted by and commissioned in the Navy, they become adjuncts of the fleet hospital ship or serve as hospitals for advanced naval bases. If converted and equipped by humanitarian societies such as the Red Cross, they may be placed at the disposal of the Army or Navy.

(c) *Hospital transport*.—A hospital transport is usually a converted commercial vessel, designed and equipped for evacuation of appropriate cases from the theater of operations to the zone of the interior, and controlled by either the Army or Navy.

(d) *Ambulance ships*.—Obsolete naval vessels, usually destroyers, may be equipped and employed as ambulances to transport patients from combatant naval vessels, or from evacuation hospitals on shore, to hospital ships.

(2) *Boats*.—(a) *Ambulance boats*.—Ambulance boats are motor-propelled craft of varying size and design controlled by the Navy and intended solely for the purpose of evacuating patients from shore or combatant ship to hospital ship.

(b) *Motor launches*.—Figure 159 shows motor launch with patient, approaching hospital ship. Naval motor launches of the Class A (50-foot) and B (40-foot) types may be used for beach evacuation during a landing operation. (See FM 8-25.)

(c) *Air Corps rescue boats*.—The Air Corps of both the Army and Navy possess small, high speed motorboats, known as "crash boats", and maintained in constant readiness for rescue work in the event of forced landings or crashes of aircraft in water. The Army rescue boat is 72 feet long and has a 16-foot beam, two 600-horsepower gasoline motors, and a cruising speed of 30 miles per hour. Besides a crew of four, it carries a complete radio installation, medical supplies and

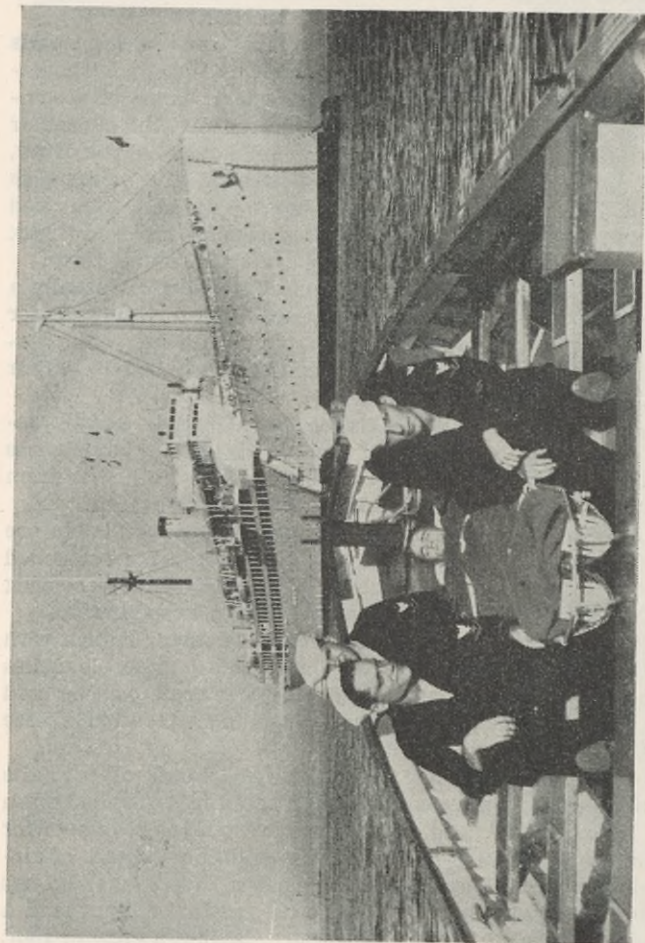

FIGURE 159.—Motor launch approaching hospital ship.

equipment, facilities for fighting fire, and the necessary gear for towing disabled planes.

(d) *Assault boats.*—The assault boat, an item of engineer equipment, is employed in the initial phase of river crossings and similar operations for ferrying combat troops. These boats on their return trips may be utilized for the evacuation of casualties, pending bridge construction. (See FM 5-5).

(e) *Miscellaneous.*—In an emergency, any available craft such as canoes, rowboats, outboard motorboats, and towboats will be employed.

(3) *Lighters.*—Lighters, or barges, of varying sizes and types may be employed in the evacuation of casualties from shore to ship, or from combat to communications zone, utilizing inland waterways.

b. *Naval classification of hospital ships.*—See FM 8-25.

c. *Classification based on immunity to attack.*—(1) *Vessels immune to attack.*—Under provisions of the Hague Convention of October 18, 1907, any vessel regardless of size if intended only for the care or transportation, or both, of the sick, wounded, or shipwrecked may become immune to attack by a belligerent by conforming to certain requirements, including the following:

(a) The painting will be distinctive, and in conformity with current international agreement.

(b) The Red Cross flag will be flown.

(c) The vessel will be announced to the enemy prior to its employment.

(d) It will be manned and staffed by noncombatant personnel.

(e) It will not be employed for any military or unneutral purpose such as the transportation of armed forces, military supplies, or military communications.

(2) *Vessels liable to attack.*—Any vessel, even though it is intended primarily for the transportation or care of the sick and wounded, which at any time performs a military mission, is liable to enemy attack. For example, a hospital transport, carrying troops or supplies, other than medical, to a theater and returning with casualties, is not immune to attack.

■ 58. SELECTION OF VESSELS FOR HOSPITAL TRANSPORTS.—Within the limits of availability, commercial vessels for con-

version and employment as hospital transports should be selected with the following points receiving careful consideration:

a. Type.—Because of the relative adequacy of messing, fresh water, laundry, latrine, and other important facilities, types of vessel, in order of preference, are passenger, combination passenger and cargo, and cargo.

b. Means of propulsion.—Unless the availability of fuel is a pertinent factor, engines utilizing oil rather than coal are preferable. The type engine and the number of propellers should be investigated with a view to reducing noise and vibration to a minimum. Fuel storage space must be commensurate with the desired cruising radius.

c. Size.—Unless the duty to be performed and the distance to be traversed dictate otherwise, a vessel of about 10,000 tons, capable of transporting from 350 to 500 patients after conversion, is preferable. Larger vessels have difficulty in entering small harbors and estuaries; supplying their fuel and water becomes more difficult; and, with less than a full load of patients, employment will be uneconomical.

d. Speed.—If not immune to enemy attack, a hospital transport should be capable of equaling the speed of the train or convoy accompanying it. If immune, the speed should be commensurate with the distance to be traversed. Other factors being normal, a cruising speed of 15 knots with a few knots reserve is most satisfactory. Greater speed increases vibration and decreases the cruising radius.

e. Steadiness.—The comfort of patients is influenced to a marked degree by the steadiness of the vessel and this factor, which varies even in similar craft, should be determined prior to selection.

f. Odors and infestation.—Due to the difficulty of complete eradication, vessels which have been carrying odoriferous cargoes or which have been infested recently with insects or vermin should be avoided.

■ 59. CONVERSION OF SELECTED VESSELS.—Details in the conversion of commercial vessels into hospital transports will vary with the type selected, the distance to be traversed, and the type patients to be transported. General guides for consideration incident to such conversion are as follows:

a. Wards.—Wards having a patient capacity of approximately 50 patients will allow economical employment of personnel. Dining rooms and salons become excellent wards. With the exception of a few for selected cases, cabins should be converted into wards by the removal of partitions as indicated. Doors should be altered to permit free entry of wheeled litters. Wards for bed patients should be located, preferably, amidships and on decks above the main deck; those for ambulant patients may be on or below the main deck.

b. Airspace.—The amount of airspace must be adequate but the exact amount will depend upon the location of the ward, number of portholes, and efficacy of the ventilating system, if any.

c. Facilities, offices, and quarters.—Service facilities, such as laundry, bakery, and galleys, should be located aft; quarters for duty personnel, forward. Professional facilities, such as X-ray, physio-therapy, and dental clinics, should be located amidships or forward and may be below the main deck.

d. Toilets.—Lavatories should be located proximal to the wards they are to serve, and should contain sufficient fixtures to accommodate 5 percent of the patients at one time.

e. Diet kitchens.—A diet kitchen, with facilities for heating and rapid serving of patients' meals, should be adjacent each large ward.

f. Lights.—Primary and auxiliary lighting systems should be installed, with special fixtures for indirect floor lighting.

■ 60. RESPONSIBILITY.—Responsibility for the command aboard a hospital transport (or ship) will vary with the situation and status of the vessel.

a. Joint Army and Navy oversea operation.—See FM 8-25.

b. Vessel under Army control.—Hospital transports under Army control will be commanded and operated by personnel, civilian and otherwise, of the Quartermaster Corps. Patients and medical personnel will be commanded by a medical officer.

c. Vessels immune to attack.—Command responsibilities aboard a vessel having immunity under the provisions of the Hague Convention, especially those manned and equipped by benevolent societies, may be complicated. The operating personnel may be civilian or merchant marine, and the med-

ical personnel, civilian, Army or Navy Medical Department. In any case where there is question as to who will be responsible for the safety and navigation of the vessel and who will command the crew, medical personnel, and patients, the rules in (1) and (2) below should be followed:

(1) The fields of responsibility for each individual concerned should be set forth in writing by the proper authority, prior to sailing.

(2) Those concerned must employ the utmost tact and give the fullest mutual cooperation at all times.

INDEX

	Paragraphs	Page
Air Corps:		
Airplane ambulance group.....	47	143
Control.....	48	146
Employment.....	47	143
Organization.....	47	143
Personnel.....	47	143
Rescue boats.....	57	161
Units for evacuation.....	47	143
Control.....	48	146
Designation.....	47	143
Employment.....	47	143
Organization.....	47	143
Personnel:		
Operating.....	47	143
Medical.....	47	143
Air evacuation:		
Advantages.....	43	137
Airplane ambulance.....	46	140
Areas of employment.....	44	138
Status of, present.....	42	137
Superiority, air, as factor.....	42	137
Type patient.....	45	139
Units.....	47	143
Air Corps.....	47	143
Control.....	48	146
Medical Department.....	47	143
Airplane. (See also Air Corps.)		
Ambulance.....	46	140
Areas of employment.....	44	138
Requirements.....	46	140
Sources.....	46	140
Types.....	46	140
Units.....	47	143
Commercial, conversion.....	46	140
Crashes:		
Evacuation of, by boat.....	56	161
Rescue, by boats.....	57	161
Transportation of the sick and wounded.....	42-48	137
Ambulance:		
Airplane.....	46	140
Animal-drawn.....	32	118
Four-animal.....	32	118
Requirements.....	34	129
Status.....	34	129
Two-animal, description.....	32-34	118
Boats.....	57	161
Definition.....	32	118
Employment, in field.....	35	130
Insert, Carlisle.....	33	122
Instruction in loading and unloading.....	37-41	131
Preparation.....	37	131
Purpose.....	37	131

INDEX

	Paragraphs	Page
Ambulance—Continued.		
Loading, general rules.....	37	131
Metropolitan.....	32	118
Motor, field.....	32	118
Requirements.....	33	122
Status.....	33	122
Motor, field, cross country.....	32	118
Capabilities.....	33	122
Description.....	33	122
Panel body.....	33	122
Personnel:		
Animal-drawn ambulance.....	34	129
Motor ambulance.....	33	122
Training.....	36	131
Posts.....	38	132
Ships.....	57	161
Transportation of the sick and wounded.....	32-41	118
Arms carry:		
Instruction.....	10-11	29
Procedure:		
One bearer.....	7	2
Two bearers.....	8	15
Assault boat.....	57	161
Barges, transportation of sick and wounded.....	57	161
Battalion, medical, airplane ambulance.....	47	143
Company, medical.....	47	143
Headquarters detachment.....	47	143
Organization.....	47	143
Status.....	47	143
Bearer:		
Actions in instruction:		
Ambulance loading.....	38-41	132
Litter.....	19-24	45
Wheeled litter carrier.....	30-31	110
Designation.....	19	45
Employment of litter bearers.....	16-17	45
Movement of patient:		
One bearer.....	7	2
Two bearers.....	8	15
Number in litter squad.....	19	45
Transportation of the sick and wounded.....	6-12	2
Boats:		
Ambulance.....	57	161
Assault.....	57	161
Launches, motor.....	57	161
Rescue, Air Corps.....	57	161
Transportation of the sick and wounded.....	57	161
Cacolet:		
Definition.....	28	103
Transportation of the sick and wounded.....	28	103
Types.....	28	103
Carlisle.....	28	103
First Cavalry Division.....	28	103
Hamilton chair.....	28	103
Panama Jungle.....	28	103

INDEX

Car (<i>see also</i> Hospital trains):		
Standard:	Paragraphs	Page
Baggage -----	51	147
Chair -----	51	147
Carrier, wheeled litter (field):		
Advantages -----	26	98
Description -----	26	98
Employment of, in field -----	27	103
Instruction in use -----	29-31	110
Formation -----	29	110
Loading and unloading -----	31	115
Objectives -----	29	110
Opening and closing -----	30	110
Purpose -----	29	110
Purpose -----	25	98
Substitutes:		
Cacolet -----	28	103
Travois -----	28	103
Transportation of the sick and wounded -----	25-31	98
Cases (patient):		
Aboard air transport:		
Comfort -----	43	137
Treatment -----	43	137
Ambulance loading -----	37	131
Ambulant -----	13	36
Back, loading and unloading -----	22	74
Capacity:		
Trains, hospital:		
Improved -----	51	147
Type -----	53	152
Transport, hospital -----	58	165
Care in handling -----	22	74
Classification -----	13	36
Litter -----	13	36
Position of, in ambulance -----	37	131
Type for evacuation by air -----	45	139
With splints, in ambulance loading -----	37	131
Corps of Engineers, operation:		
Hospital trains -----	50	147
Standard boxcar -----	53	152
Thirty-ton locomotive -----	53	152
Evacuation:		
Means. <i>See</i> Transport.		
Principles -----	4	1
Responsibility -----	5	1
Scope -----	3	1
Fireman's carry:		
Instruction -----	10	29
Procedure -----	7	2
Fleet hospital ship -----	57	161
Group, airplane ambulance. <i>See</i> Air Corps.		
Hague Convention:		
Immunity, basis of classification -----	57	161
Responsibility aboard immune vessels -----	60	167

INDEX

	Paragraphs	Page
Hospital ship:		
Definition.....	57	161
Fleet.....	57	161
Naval classification.....	57	161
Hospital trains:		
Classification.....	50	147
Employment and control.....	54	160
Improvised.....	51	147
Capacity.....	51	147
Car, hospital unit.....	52	152
Cars, standard:		
Baggage.....	51	147
Chair.....	51	127
Composition.....	51	147
Personnel.....	51	147
Sleepers:		
Pullman, standard.....	51	147
Tourist.....	51	147
Where employed.....	51	147
Status.....	50	147
Transportation of the sick and wounded.....	49-54	147
Type.....	53	152
Arrangement of cars.....	53	152
Capacity, patient.....	53	152
Composition.....	53	152
Definition.....	53	152
Description.....	53	152
Personnel.....	53	152
Requirements.....	53	152
Unit car.....	52	152
Hospital transport:		
Conversion of selected vessels.....	59	166
Air space.....	59	166
Diet kitchens.....	59	166
Facilities, officers and quarters.....	59	166
Lights.....	59	166
Toilets.....	59	166
Wards.....	59	166
Definition.....	57	161
Immunity to attack.....	57	161
Responsibility aboard.....	60	167
Selection of vessels.....	58	165
Means of propulsion.....	58	165
Odors and infestation.....	58	165
Size.....	58	165
Speed.....	58	165
Steadiness.....	58	165
Type.....	58	165
Immunity to attack, vessels.....	57, 60	161, 167
Instruction:		
Ambulance loading and unloading.....	37-41	131
Manual transport.....	9-12	27
Use of litter.....	18-24	45
Use of wheeled litter carrier.....	29-31	110
Launch, motor.....	57	161
Lighters, transportation of sick and wounded.....	57	161

INDEX

Litter:	Paragraphs	Page
Bearers, employment.....	16-17	45
Canvas:		
Aluminum pole.....	14	37
Folding.....	14	37
Wooden pole.....	14	37
Cases.....	13	36
Definition.....	13	36
Improvised.....	15	40
Doyan.....	15	40
Poles and blanket.....	15	40
Poles and blouses or overcoats.....	15	40
Poles and shelter half.....	15	40
Rifles and blanket.....	15	40
Rifles and blouses.....	15	40
Rifles and overcoat.....	15	40
Instruction in the use.....	18-24	45
Commands.....	18	45
Formation.....	21	48
Metal, airplane.....	14	37
Requisites.....	13	36
Squad.....	19	45
Standardization.....	13	36
Transportation of the sick and wounded.....	13-24	36
Litter squad:		
Ambulance loading and unloading:		
Formation.....	37	131
Instruction.....	39-41	132
Composition.....	19	45
Designation.....	21	48
Designation of bearers.....	19	45
Duties of bearers in reduced squads.....	19	45
Formation.....	21	48
Instruction.....	19-24	45
Position at ambulance posts.....	38	132
To bring into line.....	21	48
Manual transport for sick and wounded:		
Arms carry:		
One bearer.....	7	2
Two bearers.....	8	15
Fireman's carry.....	7	2
Instruction.....	9-12	27
Commands.....	9	27
Formation.....	9	27
Purpose.....	9	27
Methods.....	7-8	2
Pack-saddle carry.....	8	15
Saddleback carry:		
One bearer.....	7	2
Two bearers.....	8	15
Supporting carry:		
One bearer.....	7	2
Two bearers.....	8	15
Transportation of the sick and wounded.....	6-12	2
When required.....	6	2

INDEX

	Paragraphs	Page
Oversea operations:		
Joint Army and Navy.....	56	161
Responsibility.....	60	167
Separate Army.....	56	161
Pack-saddle carry:		
Instruction.....	11	33
Procedure.....	8	15
Personnel:		
Airplane Ambulance Group.....	47	143
Ambulance:		
Animal-drawn.....	34	129
Motor.....	33	122
Hospital trains:		
Improvised.....	51	147
Type.....	53	152
Medical Battalion, Ambulance Group.....	47	143
Quartermaster Corps, operation of hospital transport.....	60	167
Rail transportation of the sick and wounded.....	49-54	147
Employed:		
When.....	49	147
Where.....	49	147
Employment and control.....	54	160
Hospital trains:		
Classification.....	50	147
Improvised.....	51	147
Status.....	50	147
Type.....	53	152
Hospital Unit car.....	52	152
Means of transport.....	49	147
Rescue boats, Air Corps.....	57	161
Responsibility:		
Aboard hospital ships.....	60	167
Air evacuation units.....	48	146
Evacuation.....	5	1
Hospital trains.....	50	147
Of ambulance:		
Assistant driver.....	34	129
Chauffeur.....	33	122
Driver.....	34	129
Orderly.....	33	122
River crossings:		
Employment of assault boats.....	57	161
Evacuation of casualties.....	56	161
Saddleback carry:		
Instruction.....	10-11	29
Procedure:		
One bearer.....	7	2
Two bearers.....	8	15
Ships:		
Ambulance.....	57	161
Fleet hospital.....	57	161
Hospital.....	57	161

INDEX

Ships—Continued.	Paragraphs	Page
Hospital transport.....	57	161
Conversion of selected vessels.....	59	166
Responsibility aboard.....	60	167
Selection of vessels.....	58	165
Transportation of the sick and wounded.....	57-60	161
Sleeper:		
Pullman, standard.....	51	147
Tourist.....	51	147
Supporting carry:		
Instruction.....	10-11	29
Procedure:		
One bearer.....	7	2
Two bearers.....	8	15
Train, hospital, transportation of sick and wounded.....	49-54	147
Transport:		
Airplane.....	42-48	137
Ambulance.....	32-41	118
Gacolet.....	28	103
Carrier, wheeled litter.....	25-31	98
Choice.....	3	1
Litter.....	13-24	36
Manual.....	6-12	2
Train.....	49-54	147
Travois.....	28	103
Water.....	55-60	161
Transportation of the sick and wounded:		
Air.....	42-48	137
Ambulance.....	32-41	118
Bearer.....	6-12	2
Carrier, wheeled litter.....	25-31	98
Rail.....	49-54	147
Water.....	55-60	161
Relation to medical task.....	3	1
Travois.....	28	103
Improvisation.....	28	103
Transportation of sick and wounded.....	28	103
Two-horse.....	28	103
Water transportation of the sick and wounded.....	55-60	161
Classification of transport.....	57	161
Conversion of selected vessels.....	59	166
Military application.....	55	161
Responsibility.....	60	167
Selection of vessels.....	58	165
When employed.....	56	161

MEDICAL FIELD MANUAL

TRANSPORTATION OF THE SICK AND WOUNDED

CHANGES }
No. 1 }

WAR DEPARTMENT,
WASHINGTON, 8 June 1943.

FM 8-35, 21 February 1941, is changed as follows:

- 13. GENERAL.—*a. Litter, definition.*—A litter is a rectangular framework across which is placed canvas or other material and is used to transport sick, wounded, or dead persons.

* * * * *

[A. G. 300.7 (6-2-43).] (C 1, 8 June 1943.)

BY ORDER OF THE SECRETARY OF WAR:

G. C. MARSHALL,
Chief of Staff.

OFFICIAL:

J. A. ULIO,
Major General,
The Adjutant General.



FM 8-35

10

MEDICAL FIELD MANUAL

TRANSPORTATION OF THE SICK AND WOUNDED

WAR DEPARTMENT,
WASHINGTON, 8 June 1918.

NUMBER
NO. 2

FM 8-35, 21 February 1917, is changed as follows:

12. GENERAL. a. Litter definition.—A litter is a rectangular framework across which is placed canvas or other material and is used to transport sick, wounded, or dead persons.

(A. G. 3007 (8-2-18), (C. I. 3 June 1918).)

BY ORDER OF THE SECRETARY OF WAR:

G. C. MARSHALL,
Chief of Staff.

OFFICIAL:

L. A. UTO,

Major General,

The Adjutant General.

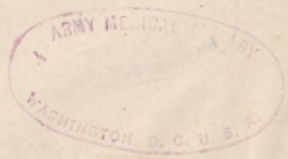

NATIONAL RESEARCH COUNCIL
DIV. OF MED. SCIENCES
Office of Medical Information
MEDICAL FIELD MANUAL

Indexed
FM 8-35

C 2

TRANSPORTATION OF THE SICK AND WOUNDED

CHANGES }
No. 2 }

WAR DEPARTMENT,

WASHINGTON 25, D. C., 4 November 1943.

FM 8-35, 21 February 1941, is changed as follows:

■ 25.1 (Added). LITTER SECURING STRAP.—*a.* Litter securing straps are available in the ratio of four per litter. The strap consists of a length of 2-inch webbing with buckle and two metal hooks, one at each end. The purpose of the securing strap is to hold litter patients in position on the litter, thus facilitating movement and obviating danger of the patient falling from the litter. The litter securing strap is so designed as to fit all standard Army litters. The straps are used in numbers according to circumstances. When movement is over relatively level areas, two securing straps will generally be sufficient; one across the patient's chest and one across his legs below the knees. In securing the straps, one end is fastened by the metal hook to the litter pole; the strap is then carried across the patient's body and fixed to the far litter pole by the hook on the other end of the strap. When the litter is to be moved over rough terrain or the proposed movement is of such a nature that there is particular danger of a patient slipping from the litter, all four securing straps are used. The four straps may be applied one across the chest, one across the waist, one across the thighs, and one across the legs below the knees. However, when considerable movement of the litter in a vertical direction is contemplated, the following method of application is employed: two straps are applied across the chest and legs as before and the other two as follows: one is clasped to the litter pole, carried over the thigh of one leg, passed between the legs and under the other leg to the far pole. The other strap is applied in the reverse manner; that is, clasped to the far pole, carried over the thigh of the far leg, under the near leg, and finally attached to the near pole. (See fig. 103.1.)

b. Whenever litter securing straps are used, care must be taken that the strap is so placed as not to interfere with whatever wounds may be present. If the patient suffers a broken leg which has been splinted, straps are passed over only the uninjured leg, since the litter bar will serve to hold the splinted leg in position.

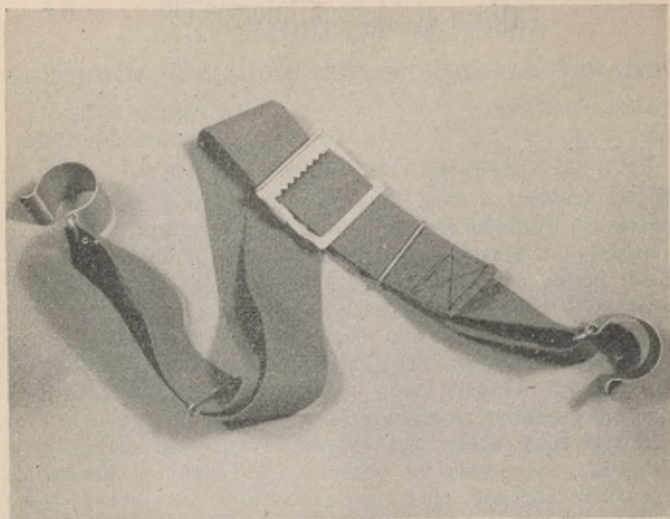

①

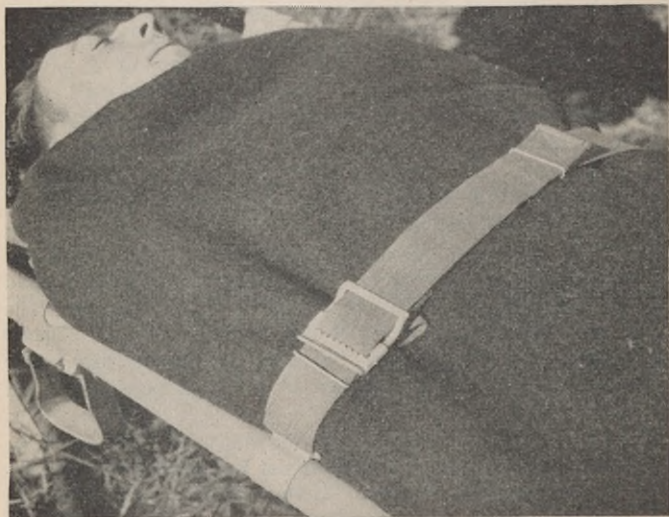

②

FIGURE 103.1.

TRANSPORTATION OF THE SICK AND WOUNDED



③

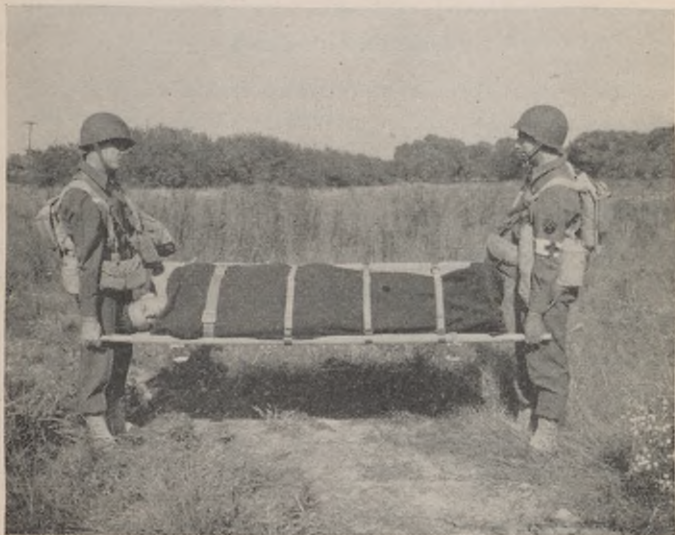

④

FIGURE 103.1—Continued.

MEDICAL FIELD MANUAL



⑤

FIGURE 103.1—Continued.

[A. G. 300.7 (22 Oct 43).] (C 2, 4 Nov 43.)

BY ORDER OF THE SECRETARY OF WAR :

G. C. MARSHALL,
Chief of Staff.

OFFICIAL :

J. A. ULIO,
Major General,
The Adjutant General.

NATIONAL RESEARCH COUNCIL
DIV. OF MED. SCIENCES
Office of Medical Information

Indexed
FM 8-35

C 3

MEDICAL FIELD MANUAL

TRANSPORTATION OF THE SICK AND WOUNDED

CHANGES }
No. 3 }

WAR DEPARTMENT,
WASHINGTON 25, D. C., 13 April 1944.

FM 8-35, 21 February 1941, is changed as follows:

CHAPTER 9 (Added)

CONVERSION OF COMMON MILITARY VEHICLES TO
PATIENT CARRIERS

■ 61. GENERAL.—*a.* Many common military vehicles can be converted into patient carriers with little or no structural change. Often in combat areas ambulances will be unavailable, too few in number, or incapable of evacuating certain regions due to the tactical situation or difficulties arising from the terrain. In such cases it becomes necessary to utilize whatever vehicles are available to transport the wounded. Methods of using several of the more common military vehicles to carry casualties are described in this chapter.

b. Most of these vehicles are not inclosed. In order to insure that the casualty does not bounce off the litter in transit, he should always be bound to the litter prior to loading on the vehicle. Straps to be used for this purpose and known as "Litter Securing Straps" are an item of issue. (See C 2, 4 Nov. 43.)

c. To insure that the litters themselves will not bounce off the vehicles, it is necessary that they be lashed securely to the sides of the various trucks after being loaded. For this purpose lengths of rope, litter straps, or any other convenient materials may be used.

d. In general, litters will be loaded as follows: when litters are lengthwise to the truck, patients' heads will be toward the front. When litters are loaded crosswise to the truck, patients' heads will be alternately right and left to minimize discomfort to adjacent patients in cases of nausea and vomiting.

■ 62. CONVERSION OF SELECTED VEHICLES TO PATIENT CARRIERS.—
a. The ¼-ton truck.—The ¼-ton truck (Jeep or Peep) and trailer are standard equipment of medical battalion sections and many other units of the Army. They will be available almost always and are easily adapted to carrying casualties.

(1) Two litter patients can be carried on the ¼-ton truck without alteration in the vehicle (other than removal of spare tire) or the use of additional equipment (fig. 160).

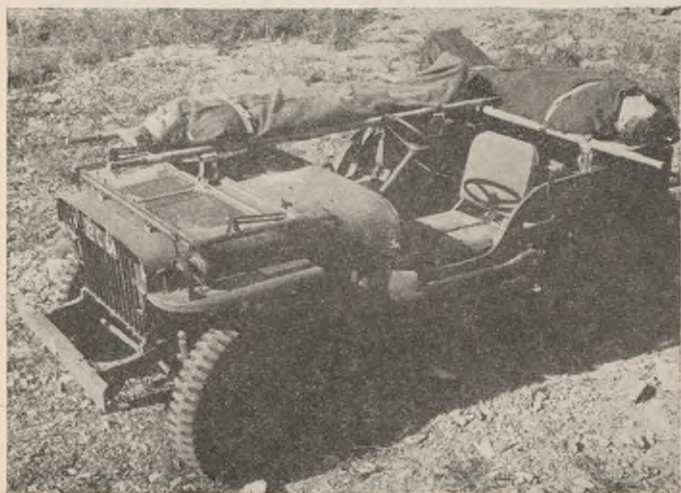

FIGURE 160.—The ¼-ton truck loaded with two litter patients.

One litter is placed across the back of the truck, handles of the litter resting on the truck sides. The second litter is placed lengthwise on the right side of the truck. The rear handles of the second litter rest on the side of the first litter, and the front stirrups fit in the groove below the windshield.

(2) A disadvantage to the method of transportation described in (1) above results from the necessity of placing the first litter crosswise to the truck. When the route of evacuation is along narrow roads or trails, there is danger of the litter handles catching on projecting trees and bushes. This danger can be obviated by construction of an improvised frame

TRANSPORTATION OF THE SICK AND WOUNDED

to permit carrying of two litter casualties lengthwise on the rear of the truck. Such a frame can be made by binding together four poles, saplings, or boards in the shape roughly of a two-rung ladder (fig. 161). The frame is lashed to the bows and side handles of the jeep with ropes or straps, and the litters loaded with patients' heads toward the front. The front of the litters rest on the front cross piece of the frame, and the back of the litters on the bows of the truck (fig. 162).

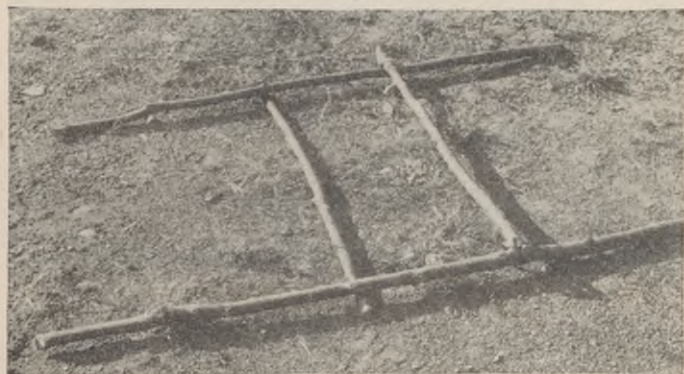

FIGURE 161.—Improved frame for $\frac{1}{4}$ -ton truck.

(3) A more permanent frame may be made from salvaged 2 by 4's or similar material (fig. 163). An advantage of this type of frame is that it can be folded up and stored when not in use. When mounted on the truck, the crosspiece of the frame is placed in position just behind the backs of the front seats. The side pieces of the frame extend to the rear and slightly inward over the corners of the truck. These pieces support the truck bows which are slid to the rear where they fit into a notch and are lashed to the side pieces. When the litters are loaded onto the truck, they are supported in front by the crosspiece of the frame, and in the rear by the truck bows (fig. 164).

(4) The $\frac{1}{4}$ -ton cargo trailer may be readily adapted to the transportation of litter casualties (fig. 165). Two litters are placed lengthwise on the trailer, with the litter stirrups fitting inside and thus preventing the litters from falling off. The

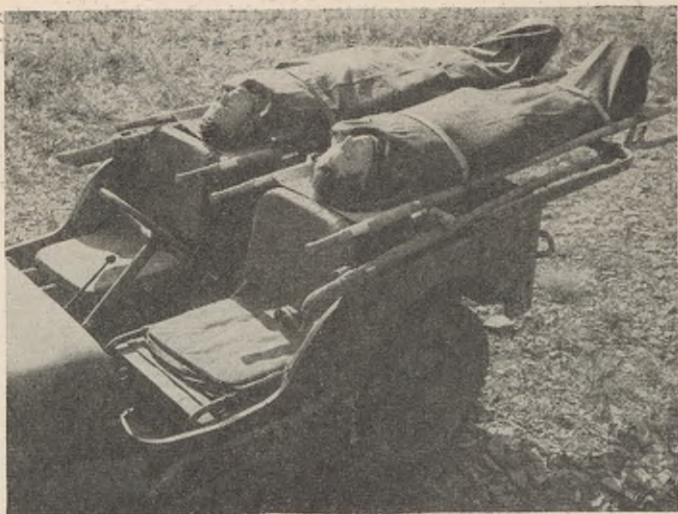

FIGURE 162.—Two litters loaded on improvised frame.

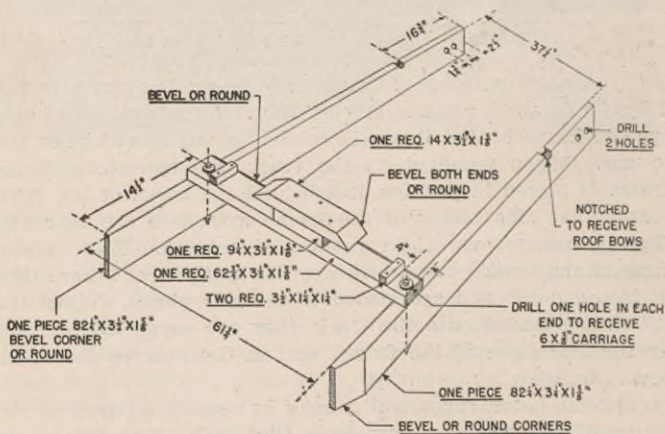

FIGURE 163.—Plan of permanent frame for 1/4-ton truck.

TRANSPORTATION OF THE SICK AND WOUNDED



FIGURE 164.—Two litters loaded onto permanent frame.

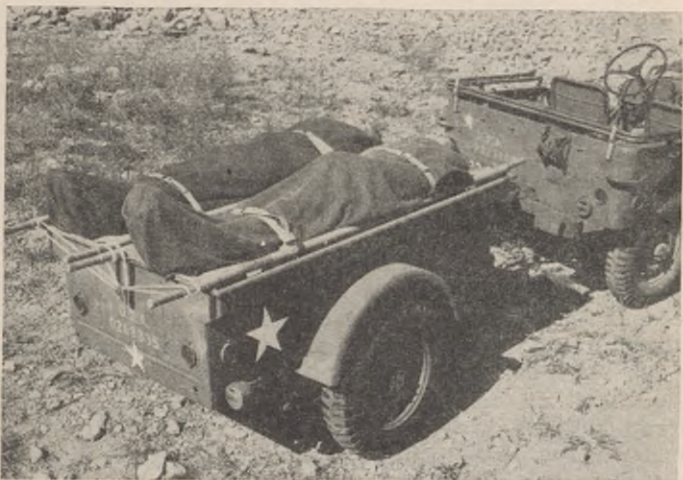
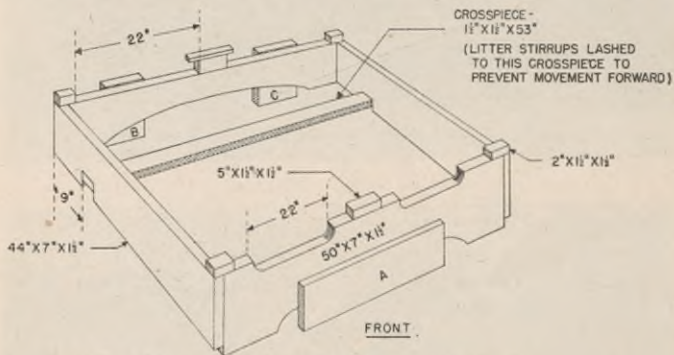

FIGURE 165.— $\frac{1}{4}$ -ton cargo trailer loaded with two litters.

litter handles are bound to the small hooks on the sideboards of the trailer.

(5) By attaching the loaded $\frac{1}{4}$ -ton cargo trailer to the $\frac{1}{4}$ -ton truck, four litter casualties may be transported. The method of litter loading described in (1) above must ordinarily be used to load the $\frac{1}{4}$ -ton truck, as use of either the improvised or permanent frames on the rear of the truck would make it impossible to attach the trailer.

(6) If it is thought desirable, a frame for two litters on the front of the truck may be constructed, thus making it possible to attach the trailer and transport four patients in a position lengthwise to the truck (fig. 166, drawing). The frame is



BLOCKS "A", "B", "C" PREVENT MOTION OF THE RACK TO FRONT OR REAR.

FIGURE 166.—Plan of hood frame for $\frac{1}{4}$ -ton truck.

placed on the hood of the truck and the litters loaded lengthwise. The rear handles of the litter extend over the dashboard with the outer handles lashed to eyebolts on the dashboard directly below. Patients' heads are toward the truck body to minimize the danger of accidents during transport (fig. 167).

b. *The $\frac{3}{4}$ -ton truck and $1\frac{1}{2}$ -ton 6 x 6 truck.*—(1) The $\frac{3}{4}$ -ton truck (weapons carrier) is a common vehicle both in the infantry and in medical units. It is easily adapted for use as a patient carrier. Two litters are placed lengthwise and head foremost in the bottom of the $\frac{3}{4}$ -ton truck, their protruding ends supported by the tail gate. The protruding ends are

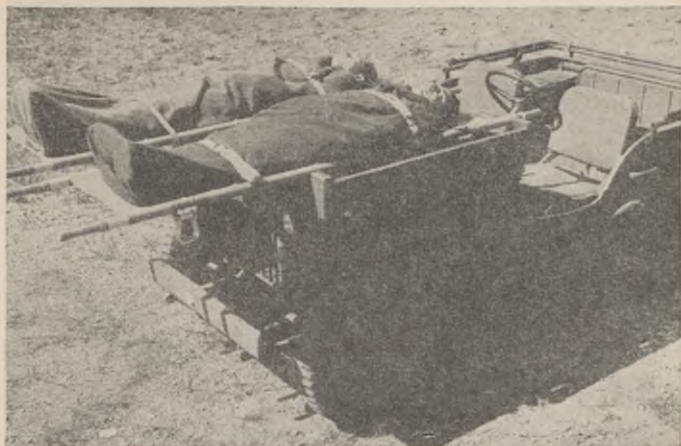

FIGURE 167.—Hood frame loaded with two litters.

bound with ropes to prevent the litters from sliding out. If the roof bows of the truck are off, a second layer of three litters is placed side by side crosswise, resting on the slats and lashed in place. If the roof bows of the truck are in position, the second layer of litters is placed crosswise so that the litter handles rest on the bow braces. The handles of the center litter straddle the center bow. The litters of the top layer are secured by lashing their handles to the bow braces (fig. 168). Thus a total of five litter casualties can be transported.

(2) The $1\frac{1}{2}$ -ton 6 x 6 truck is loaded similarly; that is, two litters lengthwise along the floor and a second layer crosswise over the bow braces. Because of the additional length of the truck body, however, five litters can be accommodated on the second layer, making a total of seven in the truck.

c. The $1\frac{1}{2}$ -ton 4 x 4 truck.—The $1\frac{1}{2}$ -ton 4 x 4 truck, a common vehicle in many organizations, is also easily adapted as a patient carrier. This truck can accommodate three layers of litters. The bottom layer consists of two litters placed lengthwise on the floor. The middle layer of four litters is placed crosswise resting on the seats of the truck, and the top layer crosswise on the bow braces. The truck is loaded from front to rear, top layer first, then middle layer, top layer, and middle



FIGURE 168.— $\frac{3}{4}$ -ton truck loaded with five litters.

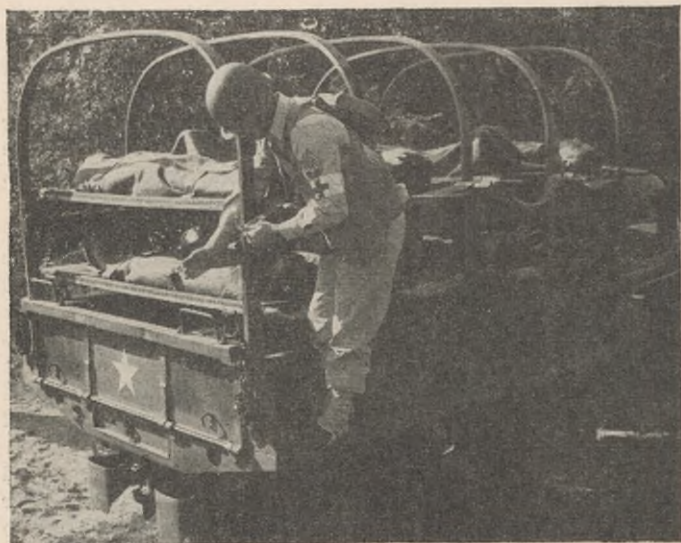

FIGURE 169.— $1\frac{1}{2}$ -ton 4 x 4 truck loaded with ten litters.

TRANSPORTATION OF THE SICK AND WOUNDED

layer in alternation until the two upper layers are filled. Then the 2 litters on the floor are slid in from the rear. The tail gate is raised and fastened, and the litters of the two upper layers secured to the seats and bow braces by straps (fig. 169). Thus the capacity of the truck is ten litters.

d. The 2½-ton truck.—The 2½-ton truck, another vehicle of wide general use, is loaded similarly to the 1½-ton truck but has a greater capacity. The upper, middle, and bottom layers are again placed on the bow braces, on the seats, and on the floor, respectively. The floor of the truck will accommodate six litters in two rows of three litters each loaded lengthwise to the truck in the following manner: the two side litters are placed on the floor first and then slid sideways until they are under the seats. Then the center litter is placed between the two. The back three litters protrude from the floor of the truck and are supported by the tail gate which cannot be closed. The entire truck is loaded from front to rear in any convenient order, care being taken not to obstruct placing of one litter by premature loading of another. Finally the litters are bound securely to the bow braces and the tail gate raised slightly above the horizontal to prevent slipping. The truck when fully loaded permits transportation of eighteen litter patients (fig. 170).



FIGURE 170.—2½-ton truck loaded with eighteen litters.



FIGURE 171.—Half-track loaded with four litter patients plus medical personnel.

e. The half-track.—(1) The half-track is a common vehicle in the armored force and is used as an ambulance for armored force medical detachments. When so employed, it will conveniently accommodate four litter patients, plus four slightly wounded patients or medical attendants (fig. 171). The litters are loaded in layers of two litters each lengthwise to the vehicle body. Certain structural changes (fig. 172) in the

TRANSPORTATION OF THE SICK AND WOUNDED

vehicle are required to support the litters as follows. U-shaped brackets are mounted on the gun pedestal to support the inner front handles of the four litters. Rings are suspended from chains fastened to the vehicle backplates and sideplates to support the inner rear handles of the four litters, as well as the outer front handles of the two top litters. The outer rear handles of the two top litters are supported on brackets welded to the rear plates. The outer front handles of the two bottom litters rest on the vehicle seats.

(2) An alternative method of loading the half-track may be

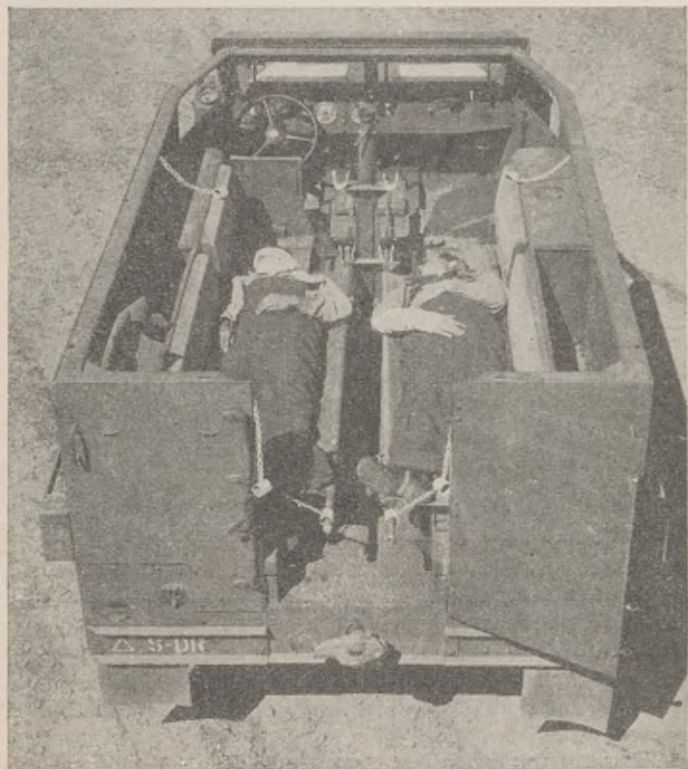

FIGURE 172.—Half-track converted for patient carrier.

employed when it is not considered desirable or feasible to make structural changes in the vehicle itself (fig. 173). Five litters are mounted across the top of the half-track, then an additional litter is slid lengthwise into the vehicle on the floor. A disadvantage of this method results from the difficulty of lashing the five top litters in place. However, this can be accomplished if sufficient rope or other suitable material is available.

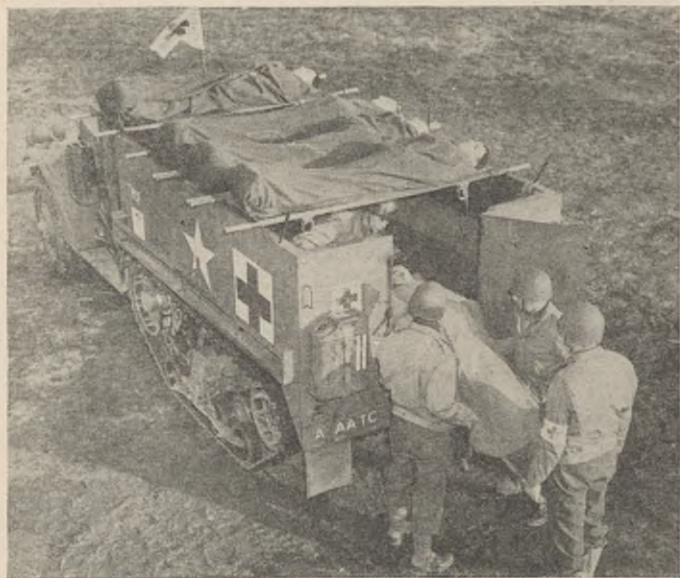

FIGURE 173.—Loading half-track (alternative method).

(3) In cases of emergency, nine litter patients can be transported in the half-track by combining the two methods described above. The required structural changes must first be made, after which four litters are loaded into the vehicles. Then five additional litters are loaded crosswise on the top of the half-track.

f. The 2½-ton amphibian truck.—(1) The 2½-ton amphibian truck (DUKW) can be adapted as a patient carrier. The

TRANSPORTATION OF THE SICK AND WOUNDED

vehicle will usually be available only to troops engaged in or contemplating amphibious operations. It is most useful in transferring casualties from shore landing parties to ships nearby. The same truck that brings supplies to the shore may carry wounded men back to the ship. The truck may be loaded at the unit aid station, then driven down to the shore and out to the ship, or it may be loaded at the water's edge (fig. 174).



FIGURE 174.—Loading the 2½-ton amphibian truck.

(2) To convert the 2½-ton amphibian truck to a patient carrier the bows are first loosened and slid forward where they are bound in place against the front bow. Five litters can then be placed on the bottom of the truck, two crosswise in front and three lengthwise in the rear. In order to rest litters on the sides of the truck and thus make a second layer, it is necessary to construct a rail along each side of the truck just outside and above the side. This rail is held in place by a special bracket which clips on the side of the truck. When litters are placed across the sides of the truck, their handles abut against the rail, preventing the litters from sliding off. Six litters can be loaded side by side across the top. The

MEDICAL FIELD MANUAL

capacity of the truck fully loaded is eleven litter casualties, five on the bottom and six on top. All litters must be tied securely in place so that they will not slide around or be displaced by rocking of the truck in rough water.

[A. G. 300.7 (18 Feb 44).]

BY ORDER OF THE SECRETARY OF WAR:

G. C. MARSHALL,
Chief of Staff.

OFFICIAL:

J. A. ULIO,
Major General,
The Adjutant General.

NATIONAL RESEARCH COUNCIL

MEDICAL FIELD MANUAL

TRANSPORTATION OF THE SICK AND WOUNDED

CHANGES }
No. 4 }

WAR DEPARTMENT,

WASHINGTON 25, D. C., 17 August 1944.

FM 8-35, 21 February 1941, is changed as follows:

■ 7. MOVEMENT BY ONE BEARER.

* * * * *

e. (Added) *Pistol belt carry*.—(1) This carry is easily learned, can be accomplished with items of equipment which will always be present with or on the soldier, and will permit the ordinary soldier to transport a casualty with a considerable degree of comfort for long distances over all types of terrain. Although this one man carry is commonly known as the "pistol belt carry" it can be accomplished with one rifle sling and one pistol belt; two triangular bandages; two litter straps, or any other equipment that will make a loop of 2½ to 3 feet in diameter.

(2) After treating the wounds, or splinting the fracture of the injured man in the appropriate manner, link together two pistol belts or other equipment to form a continuous belt under his thighs and hips so that a loop extends from each side. (See fig. 18.1.) Then lie between the wounded man's extended legs, thrusting your arms through the belt loops. (See fig. 18.2.)

(3) Grasp or support the wounded part with free hand, then, rolling toward the uninjured side, turn over to the prone position, carrying the wounded man onto your back. Make necessary adjustments of slings before proceeding. (See fig. 18.3.)

(4) Then rise to kneeling position. The continuous belt will hold casualty firmly in position. (See fig. 18.4.)

(5) Place one hand on your knee for support, then rise to upright position. The patient is now supported on your shoulders and held in position by the continuous belt, and will ride comfortably whether conscious or not. (See fig. 18.5.)

(6) You are now ready to move with your hands and arms unencumbered by the necessity of supporting the patient. You can use your hands to assist you in climbing steep banks or in surmounting all types of obstacles. (See fig. 18.6.)



FIGURE 18.1.



FIGURE 18.2.



FIGURE 183.



FIGURE 18.1.



FIGURE 18.5.

TRANSPORTATION OF THE SICK AND WOUNDED



FIGURE 18.6.

MEDICAL FIELD MANUAL

(7) A strong man can carry another for quite some distance in this manner without undue fatigue. In certain cases the carry may be substituted for litter bearers in rough or mountainous terrain, and can easily be used as a method for carrying medical equipment.

[A. G. 300.7 (26 May 44).]

BY ORDER OF THE SECRETARY OF WAR:

G. C. MARSHALL.

Chief of Staff.

OFFICIAL:

J. A. ULIO,

Major General,

The Adjutant General.

DISTRIBUTION:

As prescribed in paragraph 9a, FM 21-6; B (2); R (2) except R8 (10); Bu 8. 19 (5), 18 (2); C 8 (10).

For explanation of symbols, see FM 21-6.

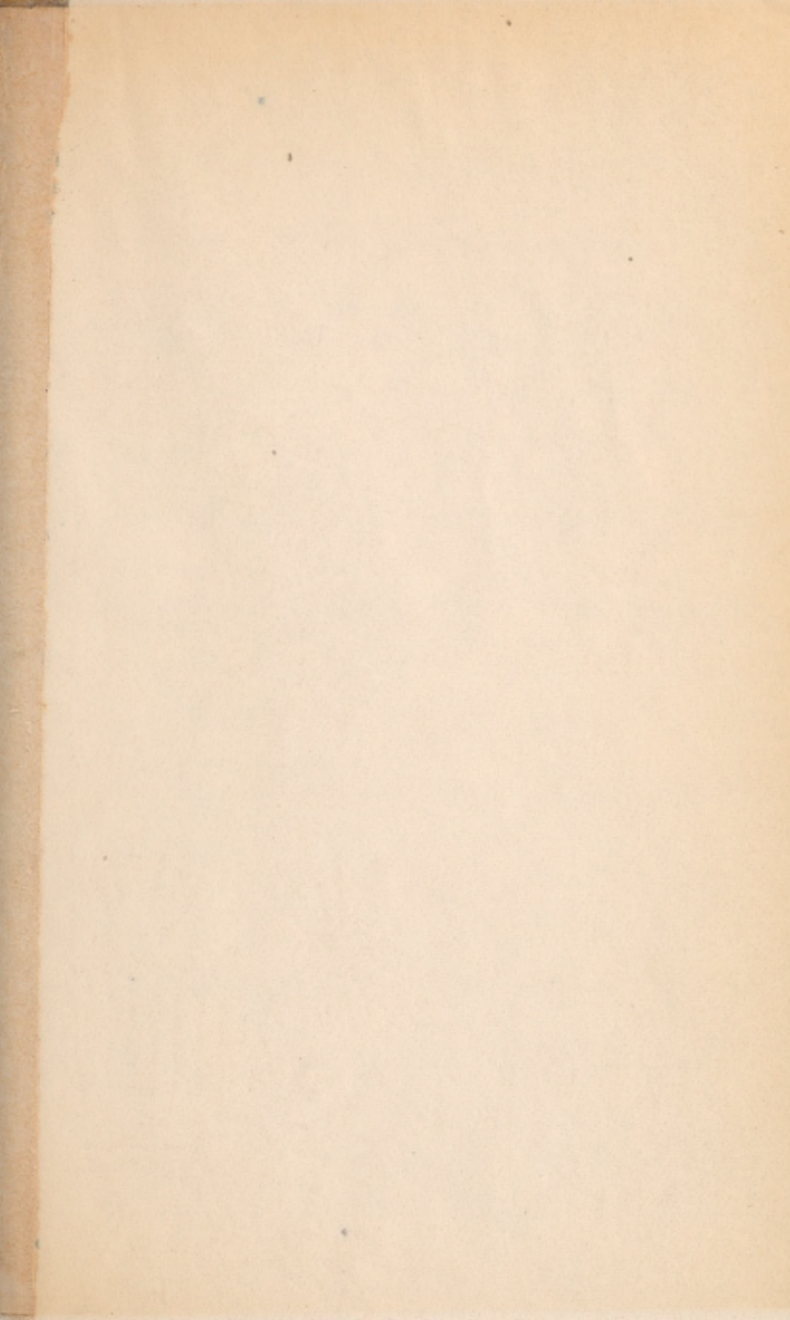





NATIONAL LIBRARY OF MEDICINE



NLM 00076533 6