

MARTIN (T.C.)

REPRINTED FROM

THE

Electrical Engineer.

A WEEKLY REVIEW OF THEORETICAL AND APPLIED ELECTRICITY.

(Copyright 1891, by THE ELECTRICAL ENGINEER, 150 Broadway, New York.)

NEW YORK, NOVEMBER 11, 1891.

COUNTING A NATION

BY

ELECTRICITY.

(A Visit to the U. S. Census Office, Washington.)



BY T. C. MARTIN.

NEW YORK:

1891.

REPRINTED FROM

THE

Electrical Engineer.

VOL. XII.

NOVEMBER 11, 1891.

No. 184.

COUNTING A NATION BY ELECTRICITY.

BY

T. C. Martin

I.

CENSUS-TAKING is a modern art. Ancient records are full of statistical information as to the number of people in certain nations at a given time, but it is to be deplored that the work was entrusted chiefly to persons of peculiar bent and aptitude for whom no other employment could then be found, namely, the romancists. In these days, such geniuses are restricted to fiction writing and the reportorial staffs of sensational papers; but at the remote period when man stood before all the great and complex facts of nature like a mere exclamation point, history was the only vent for his imagination. Hence it is safe to assume that very little of the numbering of the people at any time prior to the present century amounted to much. Every condition told against accuracy, even when it was sought in all sincerity, to true the record. The apathy or suspicion of the nation in regard to such a remote idea as its enumeration; the inability to secure a large force of skilled clerks; the obstacles of distance and primitive means of travel; the absence of comparative knowledge as to the best methods; and, finally, the doubt as to the treatment received by the returns when they were all in, even if every poll had been counted—these alone were drawbacks enough to stamp with uncertainty all the results that have come down to us.

As we have said, the art of census-taking is modern, and yet it is still, as practised in most countries of the world, as barbarous in its basis and methods as when just so many animals and a few herdsmen were told off into a patent lifeboat to try how a new start would improve social conditions. As a matter of fact, far as we here in America had gone in our plans for securing information not only as to the total of our population, but as to its peculiarities, we still used in the census of 1880 simple, crude tally sheets, which, save that the ruling on them was slightly neater, were practically the same as had done duty since the year 1. Anybody who will take up one of the old tally sheets, with its closely packed lines and serried columns, will see at a glance the difficulty and labor of transferring to them and thus massing the various interesting and important facts without which no census is now worthy of its name. The thing was as curiously inadequate to establish belief in its accuracy as is the cellar door with its chalk scratches that the saloon keeper brings to court to prove the length of a score. The only wonder to the writer is, that many of the clerks who toiled at the irritating slips of tally paper in the census of 1880 did not go blind and crazy.

II.

It was early evident that with our rapidly growing population, and the universal desire to see the returns before the generation it referred to had passed off the face of the earth, the old tallying, pencil-marking methods of 1880 would not do. The appointment of the Hon. Robert P. Porter, in April, 1889, as Superintendent of the Census, was soon followed by the naming of a commission to advise him as to the methods to adopt of tabulating census data, other than that of dallying with the primeval tally sheets. This commission, whose expert acquaintance with the subject is known to all, comprised Dr. J. S. Billings, Prof. Henry Gannett and Mr. L. M. E. Cooke. To this commission three schemes of tabulation were presented. That submitted by Mr. W. C. Hunt proposed to transfer the details given on the census enumerators' schedules to cards, distinctions being made in part by the color of the ink and in part by writing on them, the results being reached afterwards by hand sorting and counting. It should be stated here that Mr. Hunt's plan really represented the last refinement of the old methods, its author being an acknowledged authority with training in the Massachusetts Census, and now having charge of Population Statistics in the Eleventh Census as special expert agent. The next plan, that of Mr. C. F. Pidgin, contemplated the use of "chips," which should be duly assorted and counted. These chips were to be slips of paper of various colors embracing data printed in different colors so as to indicate the readings of the schedules. Thus the clerk seeking the most information would need the most chips, and, as in an analogous diversion, would wind up with having the most experience or valuable knowledge for his chips. Last, and foremost for the purposes of this article, came the system of Mr. Herman Hollerith. In this plan, the information given in the schedules was to be expressed upon cards by punching holes in them in certain positions. The tabulation from these cards was to be made by passing them through a press which would register their indications electrically on dials.

These three methods were now put to the test, four enumeration districts of the Census of 1880 in the city of St. Louis being taken. It was found that the time occupied in transcribing their contents by the Hollerith method was 72h. 27m.; by the Hunt method, 144h. 25m.; by the Pidgin method, 110h. 56m. The time occupied in tabulating was found to be as follows: Hollerith's electrical counters, 5h. 28m.; by the Hunt slips, 55h. 22m.; by the Pidgin chips, 44h. 41m. This settled it. The commission also estimated that on a basis of 65,000,000 population, the saving with the Hollerith apparatus would reach nearly \$600,000. As a matter of fact, as the saving was based on an estimate of 500 cards punched per day, while 700 is the average, the saving is 40 per cent. more than was expected. It is needless to add that Mr. Hollerith's invention was adopted, and that an arrangement was entered into by the Government with its inventor.

III.

It had been from the first a matter of great interest to the writer to know how the Hollerith apparatus would go through the ordeal, and he made an effort more than once



Herman Hollerith.

during the past six months to get such data on the subject as might prove of interest to the readers of THE ELECTRICAL ENGINEER. Each time, however, Mr. Hollerith replied that it would be better to wait until the system had given full evidence of its capacities, and that he was willing to abide by the results. His faith in his invention was certainly justifiable, but the efforts in various quarters to cast doubt on the figures obtained in the Census were such as to make a believer in the theory that electricity knows no politics, the more anxious to describe the work in progress. The statement by Mr. Porter that the population of this great republic was only 62,622,250 sent into spasms of indignation a great many people who had made up their minds that the dignity of the republic could only be supported on a total of 75,000,000. Hence there was a howl, not of "deep-mouthed welcome," but of frantic disappointment. And then the publication of the figures of New York! Rachel weeping for her lost children and refusing to be comforted, was a mere puppet-show compared with some of our New York politicians over the strayed and stolen of Manhattan Island citizens. The work of counting all those Charlie Rosses might still be going on, but perhaps this city now extracts consolation from the fact that her trans-Atlantic sister, Liverpool, finds herself similarly bereaved. As to the low "grand total" of population, Mr. Porter has the grim satisfaction of pointing to Canada. Her showing for the ten years is so bad that even if she were to call in whole provinces of the Old World to even up her ranking in the New, she would still be short many hundred thousand on the old bases of estimate. The happy truth is that as Mr. Hollerith, himself no mean mathematician, has shown, while the race is not multiplying so fast as before, its individuals are living longer. This is a state of affairs that all of us over 25 years of age, whether Republicans or Democrats, can view with equanimity. They who are loved on high no longer die between two Censuses.

It is needless to say that in all this hurly-burly of discussion over the Census and its figures, the electrical counting system came in for its share of abuse. Just why it would not work was never made clearly apparent, for all that appeared in print derogatory to the mechanism merely went to prove its wonderful simplicity and inability to go wrong. In one or two instances, the attempts to show faultiness were so puerile as to suggest that their author was either malicious or was being imposed upon. Later on, the absurdity of some of these criticisms will be shown, but it will suffice to say that they only made the present writer more anxious and keen to detect a flaw in the system and apparatus, if flaw there were. After a scrutiny as close and careful as it could be made, it seems only possible to say one thing, namely, that the apparatus works

as unerringly as the mills of the Gods, but beats them hollow as to speed. The effort will be made now to describe the system in actual operation, as witnessed two or three weeks ago, at the different branches of the Census Office in Washington.

IV.

The Eleventh Census is still of so recent date that many of the readers of this journal will remember the broadsheet schedules that were presented to them by the official enumerator to be filled up. Each of these schedules provided for some thirty details regarding any of 10 individuals. Such a sheet would therefore serve for a family or household of ten people, but as a matter of fact it was found that the average fell slightly below five; so that in the neighborhood of 13,000,000 of these schedules were sent into the Census Office, representing the work of about 50,000 enumerators. To-day these sheets, tied up in about 50,000 packages, have been appropriately deposited in one of those time-honored storehouses of vital statistics—a church—and constitute literally our modern Book of Numbers. The first thing, however, to be done with these myriad records was to get at their gross totals, and upon this work the Hollerith system was put through a kind of preliminary canter. The ingenious machine shown later in Fig. 5 was fitted with a small numbered keyboard of ordinary construction, the keys being connected electrically with the dials, which were so arranged that one of them would furnish the grand total of families as a check against the separate totals of the others for families of different sizes. The keys were in three rows, of which the top one, stamped from 1 to 8, recorded the number of families in each house. The other two rows nearer the manipulator were numbered from 1 to 10 and 11 to 20, and recorded the persons in each family. The enumerators having given this information in a little space provided at the top of their schedules, it was easy for a quick-eyed and a quick-fingered clerk to transfer the items to the dials of the machine or make special note of such rare families as exceeded 20 members. Evidently the multiplying of the number of families by the number of persons in each class would, if correct, yield the result indicated by the "total;" and hence the work was capable of very thorough check. The expertness acquired in manipulating the Hollerith machines may be inferred from the fact that some of the women tabulators thus counted as many as 50,000 persons a day, or the inhabitants of a good-sized city. The average for the women tabulators, who worked in the day time, was about 47,950 each; while the men tabulators, handicapped perhaps by coming on at night, averaged 32,935.

In this ingenious and expeditious manner, thanks to the Hollerith machines, the first, or "Dwelling House" count of the whole population of the United States as it stood on June 1, 1890, was made. Practically only six weeks were needed for the gigantic task. The announcements from the Census Office as to population of various sections followed each other rapidly, and a "rough count" for the whole country was ready as early as October 30, 1890. The last returns did not reach Mr. Porter until November 10, but he was able to issue his celebrated bulletin, giving the "official count" of 62,622,250, exactly a month later, namely, on December 12. Yet all the figures had been thoroughly checked; in reality, the people of the United States had been counted twice over. As Mr. Porter put it at a dinner given by the chiefs of the Census Office to celebrate the occasion, "For the first time in the history of the world, the count of the population of a great nation has been made by the aid of electricity" and every single one of our 62 millions "had marched as it were under the vision of the young men and women who had done such remarkable work with such extraordinary rapidity and precision."

v.

But all that we have secured so far is the total of population and a few necessary details as to size of family, and persons to dwellings. This is most important, but, as has been stated above, there are between twenty and thirty details given on the schedules as to each of the 62 millions, and pretty nearly all of those details are of the first value in revealing the make-up of the nation. The

Tenth Census, that of 1880, and led him to the invention of the apparatus described in this article. He saw that with increasing population and increasing complexity of data, the difficulties were becoming such that unless improved means of compilation were devised, the work must be abandoned in despair or become more incomplete and unsatisfactory each decade. On the other hand, with the aid of new facilities, not only might time and money be saved, but the data could be thrown into combinations full of suggestion and teaching, but which had been utterly beyond reach before. Such facilities. Mr. Hollerith has furnished in his electric tabulating system. The fundamental idea of this is, as said, to punch holes in cards so that the positions of these holes will correspond to certain data, and then to pass these cards through presses by which the perforations in the cards are made to control the operation of electromagnets or groups of magnets, which in turn energize counting mechanism or sorting boxes, or will bring both into play at once. There is no need to go into the history of the stages by which Mr. Hollerith has perfected his invention, but having already described how part of it was used for the "enumeration" and primary tabulation, it will suffice to show in what manner it performs the further and more delicate and exacting duty of compilation.

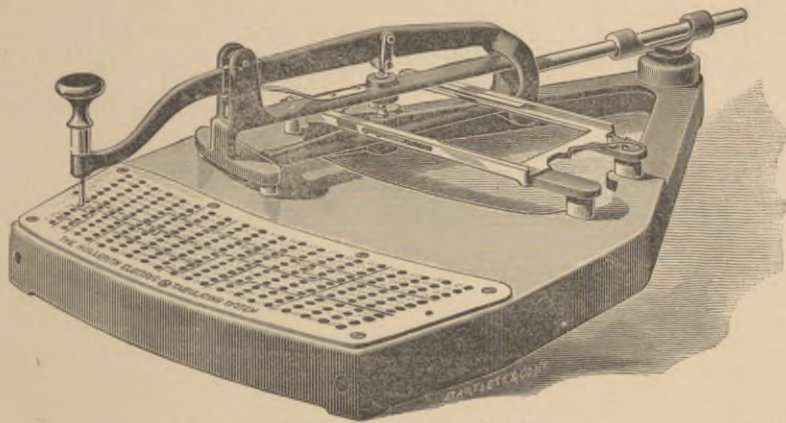

FIG. 1.—HOLLERITH KEYBOARD PUNCH.

problem that arises is, how to extract the honey from the lion's jaw; how, out of this enormous mass of returns, to elicit the facts that shall tell us what we want to know about the national characteristics—whether we are being Latinized or Teutonized in blood; whether the agricultural population increases in inverse ratio to the farm mortgages; whether city children are born merely to stimulate the trade in small coffins; whether naturalization is fashionable; whether attendance at school promises a higher state of education; whether protected industries employ many or few hands; whether a large or small proportion of the people suffer from mental or physical defect; and whether with a rising standard of comfort fecundity of the race declines. These are interesting questions, and something more. Yet it is very difficult to arrive at such combinations, and until now the obstacles have proved almost insurmountable. Thus, for example, in the Census of 1880,

vi.

Once more, then, we come back to the returns sent in by the 50,000 enumerators. In order to transfer the particulars as to each individual from these 13,000,000 schedules, Mr. Hollerith devised the machine shown in Fig. 1, known as the "keyboard punch." It is about the size of a typewriter tray, having in front a perforated punch-board of celluloid, translated in Fig. 2. Over this keyboard swings freely a sharp index finger, whose movement, after the manner of a pantagraph, is repeated at the rear by a punch. The movement of the punch is limited between two guides upon which are placed thin manilla cards 6 1/2 inches long by 3 1/2 inches high, with the lower corner slightly clipped. The keyboard, as will be observed, has twelve rows of twenty holes, and each hole has its distinctive lettering or number that corresponds to the inquiry and answer respecting

CM	UN	Jp	Ob	Oc	In	20	50	80	Dv	Un	3	4	3	4	A	E	L	a	b
CL	UL	O	Mu	Qd	Mo	25	55	85	Wd	CY	1	2	1	2	B	F	M	c	i
CS	US	Nb	B	M	0	30	60	0	2	Mr	0	15	0	15	C	G	N	o	k
No	Hd	Wf	W	F	5	35	65	1	3	Sg	5	10	5	10	D	H	O	d	l
Fb	Ft	Fm	7	1	10	40	70	4	0	1	3	0	2	St	I	P	f	m	
Hb	Hf	Hm	8	2	15	45	75	95	100	Un	2	4	1	3	4	K	Un		
X	Un	Ft	9	3	i	c	X	R	L	E	A	6	0	US	Ir	Sc	US	Ir	Sc
Ot	En	Mt	10	4	k	d	Y	S	M	F	B	10	1	Gr	En	Wa	Gr	En	Wa
W	R	OK	11	5	i	e	Z	T	N	G	C	15	2	Sw	FC	EC	Sw	FC	EC
7	4	1	12	6	m	f	NG	U	O	H	D	Un	3	Nw	Bo	Hu	Nw	Bo	Hu
8	5	2	Oc	0	u	g	a	V	P	I	Al	Na	4	Dk	Fr	It	Dk	Fr	It
9	6	3	0	P	o	h	b	W	Q	K	Un	Pa	5	Ru	Ot	Un	Ru	Ot	Un

FIG. 2.—SYMBOLS OF HOLES IN HOLLERITH CENSUS KEYBOARD.

although the returns included statements as to the conjugal condition of each and every one of the 50,000,000 inhabitants of the United States, no attempt was made to tabulate it in any way, and hence to-day we do not know what proportion of the population is married or single!

It was the absence of methods for getting speedily and surely at such results that arrested the attention of Mr. Herman Hollerith, while engaged in work upon the

every person. Hence when the index finger is pressed down into any one of these holes, the punch at the back says "ditto" by stamping out a hole in the manilla card. At first glance, perhaps, the keyboard looks complicated, but it is scientifically grouped, and, as the writer can testify, it is very readily learned. For such inquiries as are answered by one of a very few possible classes—sex, for example, which recognizes only two parties in the State—

the answer is simply "male" or "female," or "M" and "F." So, too, in regard to conjugal relationships, where the answer would be either single, married, widowed or divorced, and one punch suffices for each of these conditions of freedom or servitude. These holes may easily be found in "Dv," "Wd," "Mr.," or "CY," the last of which means that the person was married during the Census Year. Where, however, the answers would cover a wider range of classification, as in age, running from 1 to 100, recourse is had to a combination of two holes, the first indicating a group, as from 25 to 29 years, while the second hole designates the detail single year in that group. Up in the left-hand corner are double letters that bear upon the status of combatants in the Civil War, while down in the lower right hand corner are other double letters that tell one's place of birth and the place of birth of one's forebears.

To assist the clerks in memorizing the keyboard for punching, classification lists were used, which show that exactitude was sought without making it troublesome to the puncher. Thus, "Ka," standing for Germany, stands also for many divisions of the German Empire that a clerk without some such guide might be inclined to hand over again to France, Austria or Denmark. As regards the United States, each Commonwealth is designated by two letters, the first capital letter being the group, such as North Atlantic, while the small letter is the particular State. Thus, Georgia is "Bb," while Connecticut is "Ag." Now to get the run of these combinations is not difficult when once you have started. The larger percentage of all the population of any State is born within its borders, for which the hole marked "St." is provided, or else it is from two or three States near by. It follows, therefore, that, after all, the symbols "come easy" with each lot of schedules. The same remark holds true with regard to occupations. A clerk punching the card for an agricultural district has but few symbols to bother about. In many a New England town "cotton mill operative" will fit most cases. Down the Wyoming Valley, of Pennsylvania, coal miners will be apt to predominate; while out in California, fruit growers will be numerous. It will thus be seen that these innocent combinations, which a leading New York newspaper has epithetted as "refinements of torture," are no more burdensome on the memory than the details of a typewriter keyboard. On the contrary, they are vastly interesting. That the work of punching became as easy as any other

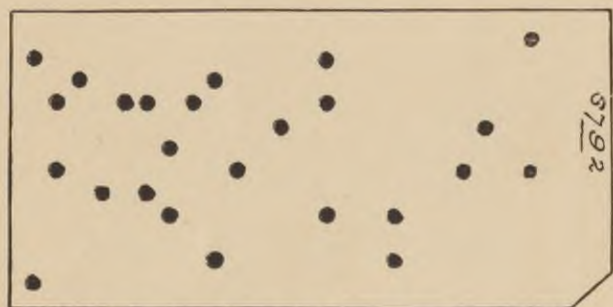

FIG. 4.—COMPLETE CARD FOR ONE PERSON.

task requiring ordinary intelligence is shown in the fact that the estimated average of 500 cards per day per clerk resolved itself very soon into an actual average of 700. It is stated that some of the more expert punchers, working from 9 A. M. to 4 P. M., have done 1,100 cards, with an aggregate of 18,700 holes, each card having 17 holes in it that relate specifically to the individual whose life history is thus condensed. Even close upon 2,000 population cards have been done in a day.

VII.

After the cards leave the punching clerks, they are kept in their Enumeration Districts, and they have now to be

further punched to show the exact locality they belong to, —i. e., the civil division of which the enumeration district formed a part. For this purpose the space of about one inch across the left-hand end of the card was left blank, no portion to the left of a fictitious line being punched on the keyboard punch. This space is further divided by imaginary lines into 48 squares, in the combinations of which every enumeration district can be recorded, and it is perforated by means of the "Gang Punch," shown in Fig. 3. The combination for any given enumeration district is arranged in this, and then all the cards of that district are passed through. From three to six cards can be punched at a time, hence the name, and pressure may be applied by either the hand or the foot. When this is done, the cards are complete, as shown in Fig. 4, which is a fac-simile



FIG. 3.—THE HOLLERITH GANG PUNCH.

slightly reduced in size, of the card for the head of a family in Chicago.

So familiar do the clerks become with the position of the holes in these cards, they can read them off at a glance. As a means of verifying, however, a "reading board" is provided for that purpose, the same size as the card, and having also each of the 240 abbreviations in a quarter-inch space, so that when a perforated card is put on this templet the abbreviation will show wherever a hole has been punched. This templet is, practically, a reduction of the original keyboard, and is about the size as our illustration of that part of the apparatus.

In one of the newspaper articles appearing recently on the subject, two alleged samples of these complete cards were given in order to show that the "chances of error were largely increased by the mechanical devices employed," while "there was small possibility of detection." The funny part about the exposé in question is that both cards lacked the impress of the gang punch, and therefore were not part of the Census record at all. In other words, they were imperfect cards that had been thrown aside by the punchers themselves, and had not even reached the Hollerith electric machines, which would have been as prompt and unerring in their rejection as are bank tellers in casting out false coin. The present writer, while in Washington, asked specially as to imperfect records, and was taken into the little room where cards rejected by the machines were being set right by reference to the original schedules. A glance at the handful of men there, revising the work made by the handling of half a million cards daily, showed the percentage of wrong cards to be very small. Where the errors were "Inconsistent," that is, where a child of 10 would be registered as of no sex, the machine would sooner or later spot the mistake and refuse to count the card. As to "consistent" errors, those namely in which a man who was a policeman might be punched with unconscious humor as a poolroom-keeper, it is safe to say that such errors were necessarily very few, if only for the reason that it is at least as easy to punch in the right hole as in the wrong one; and these errors would, moreover, on a mathematical basis, be less likely to occur in dealing with holes that are a quarter of an inch apart, than where the same record was made on lines only one-eighth of an inch apart. But besides the natural checks on errors consistent and inconsistent, was the further check of a frequent examination of the work as it proceeded day by day and hour by hour,

VIII.

These wonderful little cards have now come to stand for over 62,000,000 people. Each card is not only full of holes, but has its number, and is ready for the next stage of treatment, when each of the holes will tell its story in just the same manner as the perforations in an organette strip will cause certain notes of music to be played. The cards are stacked up on end in tin boxes, measuring 20 x 7 x 3½ inches, each box taking a trifle less than 2,000 cards. We here have a distinctively new American industry, that of canned statistics. In front of each tin box is a label stating its contents. These boxes are kept in racks in the basement of the Census quarters in the Interoccean Building. They line up ten miles long. Across the street, in the old church, are the enumerators' schedules from which they were made. Those schedules might every one of them be burned up, and the Eleventh Census could be taken over again from beginning to end, by means of the little slips of manilla in these modest little tin cans. If the record relating to each person were written in a line across a strip of paper, and the lines were half an inch apart, the roll for the nation would be nearly 500 miles long. Truly here, on these shelves, is a Liebig extract, for each can contains the essence of 2,000 human lives. In this cellar Herbert Spencer could immerse himself and study sociology with the aid of 1,000,000,000 independent facts about a single nation, but the labor-saving Hollerith machines upstairs will give them to him in significant totals down to the last degree of analysis.

IX.

Mounting by elevator to one of the upper stories of the Interoccean Building, one reaches the departments where the machines are mainly in use, and where one is again impressed with the fact that women are entrusted with much of the work. As one enters, the ear catches the sound of crisp bell ringing, for all the world like that of sleighing. This music comes from the Hollerith machines,

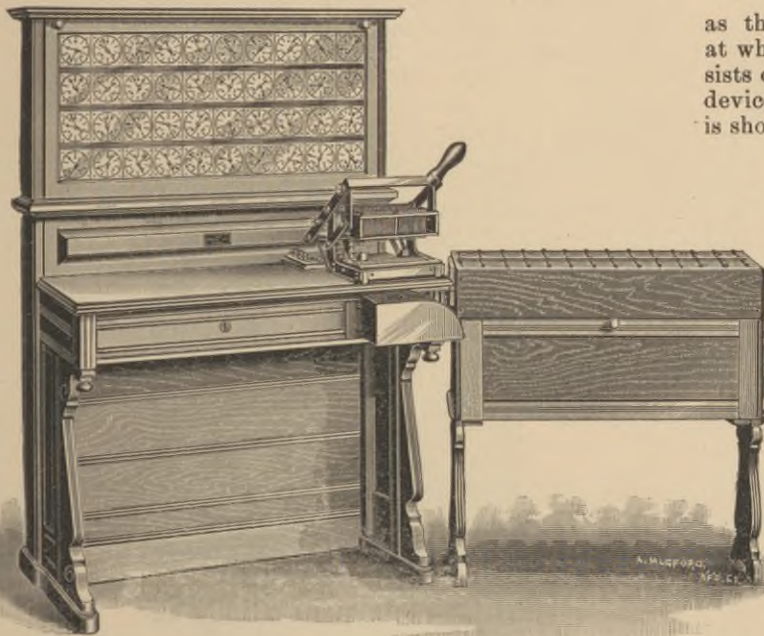

FIG. 5.—THE HOLLERITH ELECTRIC TABULATING MACHINE.

on each of which a bell, intercalated in the circuit, rings every time a card is counted, while its failure to ring indicates that there is something wrong with the card, or that it has not been slipped in properly. When the office was visited by the writer, there were 81 clerks at the machines, and their work showed 434,493 cards counted

and 121,853 sorted, or a total of 556,346 for the day, making an average of 6,868 per clerk per day. In other words, the force was piercing its way through the mass at the rate of 500 feet daily, and handling a stack of cards nearly as high

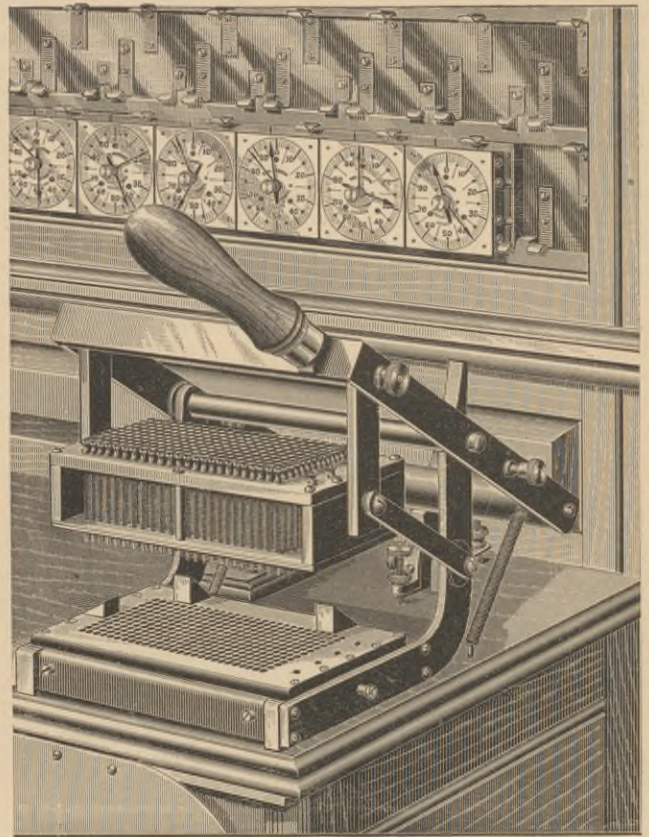

FIG. 6.—PERSPECTIVE OF CIRCUIT CLOSING PRESS.

as the Washington Monument. The Hollerith machine, at which the clerks are seated, is shown in Fig. 5. It consists of three main parts, namely, the press or circuit-closing device, the dials or counters, and the sorting boxes. The press is shown in perspective in Fig. 6 and in detail in Fig. 7. It

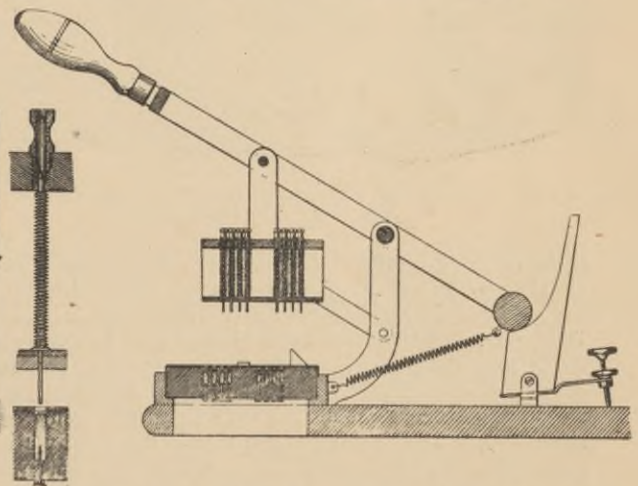

FIG. 7.—DETAILS OF CIRCUIT-CLOSING PRESS.

consists of a hard rubber plate, provided with 316 holes or pockets, the relative positions of which correspond with those of the holes in the keyboard and gang punches. Each of these pockets is partially filled with mercury, and they are thus in electrical connection, when the circuit is closed, with the binding posts and switchboard at the

back of the machine, as shown in Fig. 8, where a portion of the wooden case is broken away. Above the hard-rubber plate swings a reciprocating pin box, which is provided with a number of projecting spring-actuated points, so hung as to drop exactly into the centre of the little mercury cups below. These pins are so connected that when a punched card is laid on the rubber plate against the guides or stops and the box is brought down, all the pins that are stopped by the unpunched surface will be pressed back, while those that correspond with punched spaces pass through, close the circuit, and count on the dials. The circuit is really closed first through platinum contacts at the back of the press, and not seen in the cut. In this way no difficulty is experienced from the oxidation of the mercury from the spark, as would be the case without this precaution.

The dials are shown in detail in Figs. 9 and 10, and may also be seen grouped in position in Fig. 5. The front of

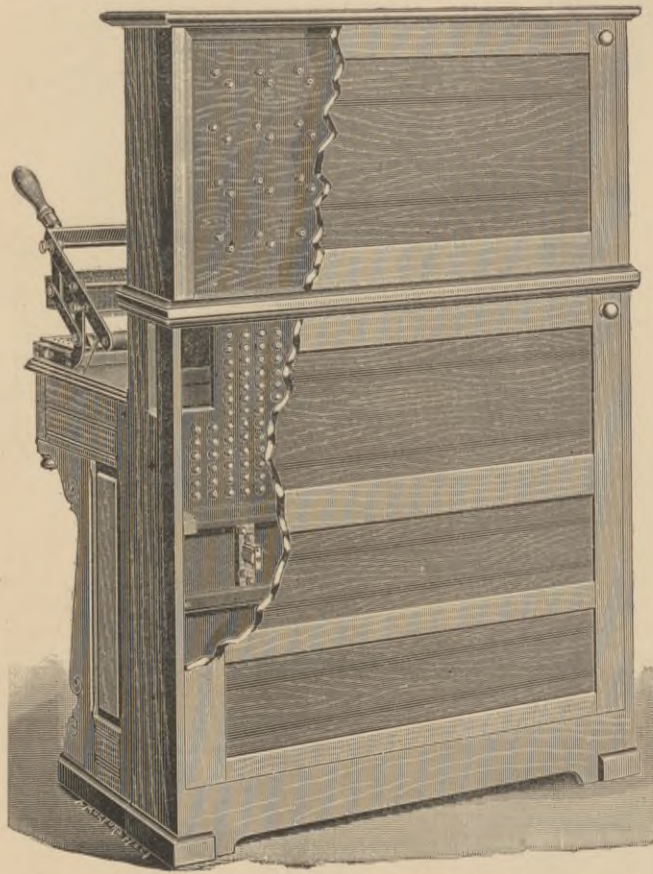

FIG. 8.—BACK OF HOLLERITH MACHINE, SHOWING SWITCH BOARD AND BINDING POSTS.

each counter is three inches square, and, as now made, consists of paper ingeniously coated with celluloid, ensuring a smooth, bright, clean face. Each dial is divided into 100 parts, and two hands travel over the face, one counting units and the other hundreds. The train of clockwork is operated electrically, by means of the electromagnet, whose armature, as it moves each time the circuit is closed, carries the unit hand forward one division, while every complete revolution actuates a carrying device, which, in turn, causes the hundred hand to count. In this way each dial will register up to 10,000. A noteworthy feature of these ingenious little dials is, that they can quickly be reset at zero, while they are also removable and interchangeable. The electrical connections are made simply by slipping them into the frames and clips shown in the upper part of Fig. 6.

The third element in the system is the sorting box shown in Fig. 11 in perspective, while Fig. 12 is a diagram

of its mechanism. The box is divided into numerous compartments, each of which is kept closed by a lid. As seen in Fig. 12, the lid *L* is held closed against the tension of the spring *S* by the catch *a* at the free end of the arma-

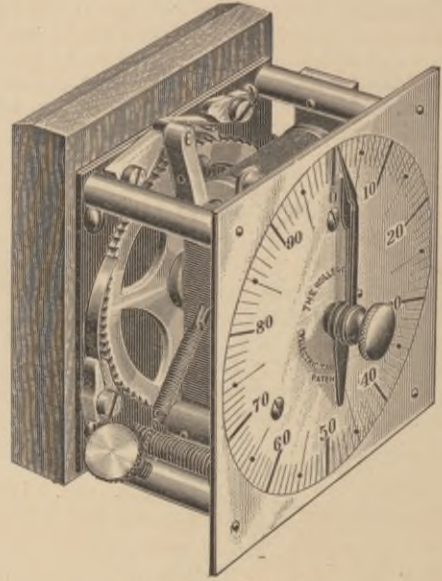

FIG. 9.—COUNTER.

ture *A*. If the circuit is closed, by the press on the machine, through the electromagnet *E*, the armature *A* is pulled down, releasing the trigger of the lid *L*, which is at once thrown up by the spring *S*, and remains open until flipped back by a slight touch of the operator's hand. The connections with the machine are made by means of the short cable seen at the left of the sorting box. In the cut the wires are shown attached to binding posts on a small board, but a minor change has been made by which the board is pushed in between contact clips in the machine, thus saving valuable time by obviating the necessity of screwing and unscrewing so many binding posts whenever it is desired to remove the box for any reason.

X.

If now, it is desired to know in a given enumeration district, or all of them, the number of males and females,

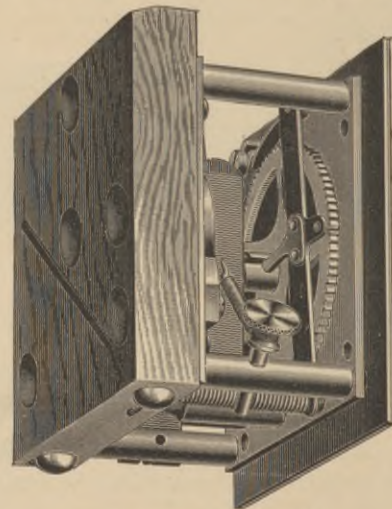

FIG. 10.—BACK OF COUNTER.

white and colored, single, married, widowed, &c., the binding posts of the switchboard corresponding with this data are connected with the binding posts of the dials on which these items are to be counted. If it is also desired

to assort the cards according to age groups, for example, the binding posts of the switchboard representing such groups are connected with the clips into which the sorting box plug fits. The circuits being thus prepared, when a card is placed in position in the press and the handle of the pin box is depressed by the operator, so that the circuit is closed through each hole in the card, not only will the registration be effected on the counting dials, but the sorting box that has been selected for a given age group is opened. The operator releases the handle, removes the card deftly from the press, deposits it in the open sorting compartment with her right hand and pats the lid down again, at the same time bringing another card into position under the press with her left hand. It is done much more quickly than it is described. When all the cards in the tin case of any district have thus gone through the press, the record taken from the dials will show the number of males, females, white, colored, &c., while the cards will have been assorted into age groups.

This is well enough, and evokes our admiration, but the Hollerith machine is capable of much more than this. In statistical work, it is found that the most valuable informa-

tion does not consist in these elementary items, but in facts that are more difficult to obtain, namely, combinations of these items. Thus, it is interesting to know how many dwellers in this country are males and how many are females; also how many are white and how many are colored. But it is at least as essential to know how many of the white males are native born or foreign born, and how many are the children of native-born or foreign parents. Hence it is desirable to provide means for counting not simply the number of white males, but the number of white males, native born, of native parents. Mr. Hollerith's machines do this as easily as they do the lighter work. The old familiar principle of the relay is brought into play very ingeniously by means of the special but simple form of relay shown in Fig. 13. These relays are mounted together in the racks at the bottom of the machine as illustrated in Fig. 8. In the case just suggested, the wire is brought from the binding post of the switch-

board corresponding to male to one contact of the relay operated from the binding post corresponding to white. From this relay the circuit runs to another relay operated from the binding posts that correspond to native birth-places. Thence again the circuit goes to the relay operated by the binding post that corresponds to native born father, thence again to the relay operated by the binding post corresponding to native mother; and finally to a counter. It will be seen therefore that the counter will only be operated when a card which has been punched for "native," "white," "male," "native-born father," and "native-born mother," and of the given age, is put under the press. If the card is not so punched, the circuit remains open at one or more points and no counting is effected. Evidently the most complex combination can be effected in this manner. An elementary manner of building up the combination is shown in diagram in Fig. 14. It is simply a question of arranging the

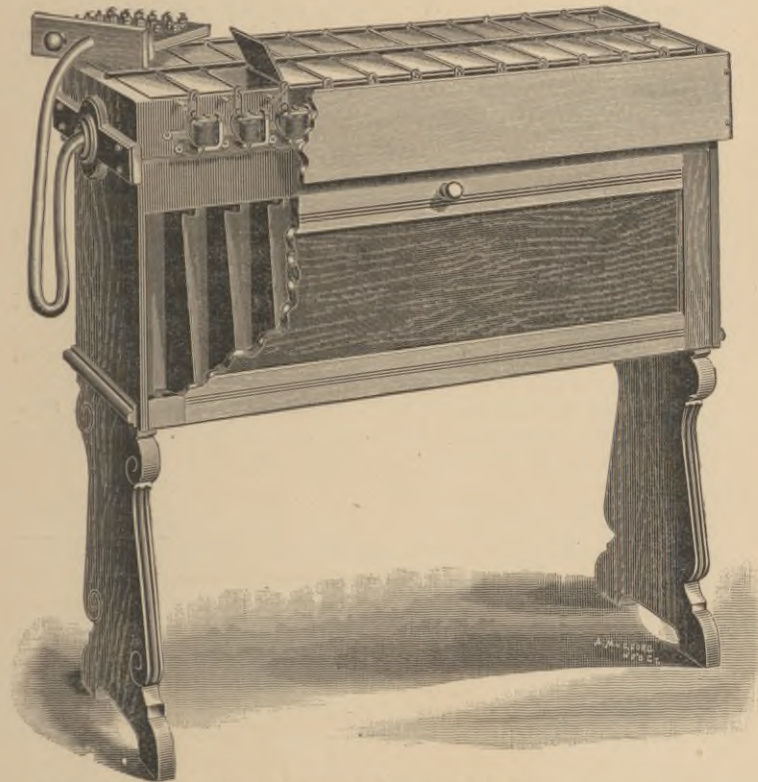

FIG. 11.—HOLLERITH SORTING BOX.

counting dials and the relays, or, if desired, the sorting boxes can be treated in the same way. When the machine is once connected up, the combination sought yields its results just as readily as though it were a single item. It is obvious, too, that multiple contact relays could be used, carrying the ability of the machine even further, if one wanted to do it in that fashion. Moreover the machine is not confined to tallying one set of facts, but will take several at one and the same time, being limited only by the number of counters.

There is another side of the Hollerith method. We have just indicated refinement in detail of one kind, but the machine lends itself to analytical work not less than synthetic. In statistical investigation the analysis naturally becomes finer as the area enlarges, and here the sorting box is of great service. As has already been stated, the cards are primarily massed in enumeration districts. For such small areas, the information required groups the popu-

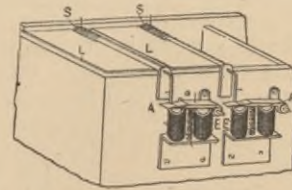

FIG. 12.—DETAIL OF SORTING BOX AND CIRCUIT.

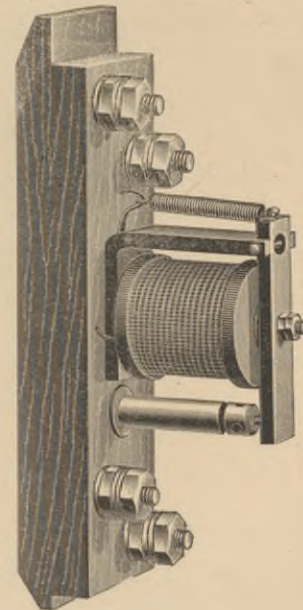

FIG. 13.—RELAY.

lation does not consist in these elementary items, but in facts that are more difficult to obtain, namely, combinations of these items. Thus, it is interesting to know how many dwellers in this country are males and how many are females; also how many are white and how many are colored. But it is at least as essential to know how many of the white males are native born or foreign born, and how many are the children of native-born or foreign parents. Hence it is desirable to provide means for counting not simply the number of white males, but the number of white males, native born, of native parents. Mr. Hollerith's machines do this as easily as they do the lighter work. The old familiar principle of the relay is brought into play very ingeniously by means of the special but simple form of relay shown in Fig. 13. These relays are mounted together in the racks at the bottom of the machine as illustrated in Fig. 8. In the case just suggested, the wire is brought from the binding post of the switch-

lation under comparatively few heads. In practice it is found that such classification can generally be counted on the 40 dials that the machine embraces normally as a full equipment; and the arrangement is made accordingly. But while counting this classification, the cards can also be assorted into groups that will form the basis of the analysis for the next larger group of territorial areas; so that if the cards are divided into twenty groups, we shall have at the next handling of the cards, a classification of 20x40, or 800 heads. If, at the next step, we subdivide each one of these twenty groups into twenty more, the third handling of the cards will give us 20x20x40 or no fewer than 1,600 heads. Thus a very few manipulations will give an extraordinarily fine degree of analysis, and the compilation will have a value from its minuteness that could be reached in no other way.

XI.

It is estimated that each of the machines thus compiles and registers information daily that would require the efforts of 20 clerks if sought by the old system of tally sheets. But that is not all. Added to the ability to secure special details, finer analysis, and the economy in time and

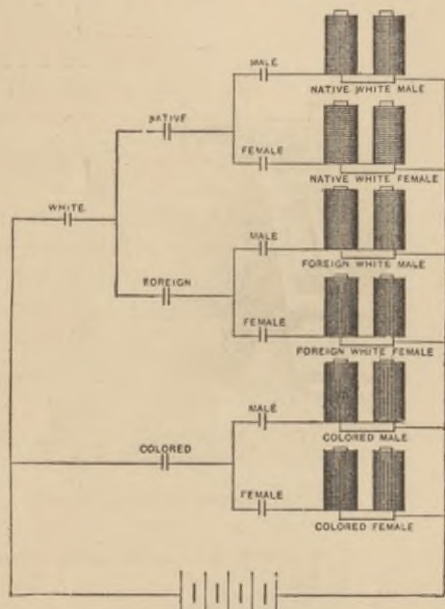

FIG. 14.—METHOD OF ARRANGEMENT FOR COMBINATION COUNTING.

labor, we have the greater accuracy. The machine automatically throws out any card that is wrong. Suppose, for instance, that age or sex has not been punched. Where there should be a hole for the plunger pin to go through, closing the circuit, the card is intact. The circuit is open, and the monitor bell just to the left of the press, refuses to give its cheery signal of correctness. It is then a very easy matter to refer back to the schedule stowed away in the old church across the street and fill up the deficiency by the paradoxical process of making a hole. Suppose it was desired to connect up the machine so that only cards for New York should be counted. A missorted card belonging to Chicago would at once be rejected with as much decision and hauteur as though it were a Knickerbocker turning the cold shoulder to a pork packer. The gang punches of the two cities not agreeing, the wrong cards would leave the circuit open. Moreover, the same indications are made of course by the same holes for all like data. If the cards of electrical engineers were assorted correctly, the hole designating the fact would show daylight through a thousand of them. If a banker fell among the bunch of thieves, the fact would be revealed again in a second, and he would be rescued from such bad company. That all are

butchers in a batch of cards purporting to represent them, is simply ascertainable by taking one of their own meat skewers and sticking it through the holes that announce the fact. But this could evidently not be done with written cards, and the digging through the 150 tons of them for such as had thus gone astray would be a job preferably postponed until such time as second sight becomes an everyday accomplishment for government clerks.

It should be pretty clear by this time that the probabilities of error in reality narrow themselves down to the punching, and, as has been pointed out, even then the only errors that escape detection are those in which the information given, while it may not furnish the exact fact, is still consistent with the other facts punched. Even these could be eliminated by comparison or check of every card, but it is surely hypercritical to complain of results so close to absolute accuracy. It is to be borne in mind, too, that a card wrongly punched involves only the possible miscounting of a single unit, whereas in all previous methods the counting up on sheets has involved possible miscount at each footing up of a column. Another point worthy of remembrance is that a large part of the punching was done by women clerks, a fact that augurs well for its conscientious performance. Whether in the dull routine of American office toil or in the discharge of the Amazonian duties described by Robert Louis Stevenson in his South Sea letters, women show a moral sense of responsibility that is still beyond the average.

XII.

As a few figures were given of the records made with the punching machines, it may be worth while, in passing, to cite some that relate to the tabulation work. It has been stated that at the time of the writer's visit to the Census Office, 81 clerks had handled 556,346 cards that day, an average of 6,868 each. The "roll of honor" shown below, obtained through the kindness of Mr. H. Sutherland, chief of the fourth division of the Census Office, includes the best records on the work of tabulation for a week at a time, with the name of the clerk, showing the number of cards and the average "readings" per day.

Name.	Week ending—	Av. per day.	
		Readings.	Cards.
Alexander, Maurice.....	July 25th....	9	13,356
Richardson, Mrs. Z.....	Sept. 26th....	7	11,351
Castillo, Angelo J.....	Oct. 3d.....	5	10,766
Johnston, Orphella.....	Aug. 22d....	6	9,515
Werner, Edgar V.....	Oct. 3d.....	5	9,475
Stockbridge, Lucetta....	Aug. 29th....	4	9,230

Below are given the six highest individual records for any one day :

Name.	Week ending—	Readings.	Cards.
Alexander, Maurice. ...	July 9th.....	9	19,071
Wasner, Mary.....	Oct. 2d.....	5	17,814
Castillo, Angelo J.....	Oct. 21st....	7	15,119
Richardson, Mrs. Z.....	Sept. 9th....	12	15,083
Ourand, Mrs. Rachel E..	Oct. 9th.....	10	13,327
Mesick, Hattie S.....	Sept. 4th....	11	13,087

In explanation it may be stated that to run so many cards through the machine and take a reading means that each card has to be put under the press and counted for each district. Then the 38 dials in the face of the machine are counted, the results are set down according to the requirements of the various result slips furnished for the purpose, addition, verification—and correction, if needed,—are made, and the clerk then starts a new district. The

day's work extends over 6½ hours, and these totals therefore show very creditable speed and expertness.

XIII.

The writer made a point while inspecting the Hollerith system, of ascertaining the opinion of the Superintendent of the Census as to the work. Mr. Porter stated emphatically that the office could not have dispensed with it. To use his own words, "he could not have got away from it." In a recent address before the American Statistical Association, Mr. Porter also dwelt upon its value for the special compilation of the statistics of mortality. Mr. W. A. King, chief of the Mortality Division of the Census Office, in a statement with regard to his own line of investigation, dwells very forcibly upon the superiority of the Hollerith apparatus for reaching detailed and accurate results. Mr. King was on the staff of the Tenth Census of 1880, and hence, is familiar with the tally sheets of that epoch. Speaking of them, he says: "In a compact tally sheet, the spaces in which the various details are tallied are close together and a very slight movement of the pencil is sufficient to produce an erroneous tally; and with any kind of a tally sheet the results sought are not known until the tally is completed, and if in the figures thus obtained a discrepancy is found by comparison with previous work, it is impossible to do more than determine the *gross* error. No means exist of locating the particular cases in which the error was made. If a re-tally is made, the error in that particular may be corrected while others are changed, or it may be made worse."

The Rev. Fred. H. Wines, another veteran of the Tenth Census, and now in charge of the statistics of Crime, Pauperism and Benevolence, the schedules for which come from the various institutions, says in a most interesting document on the general features of the Census: "The essential difference between the Eleventh Census and that which preceded it was the adoption of the card system for the tallying of results and the use of the newly invented Hollerith electrical machine for counting the cards. Too much cannot be said in praise of this machine which has enabled us to compute results with much greater rapidity and accuracy than by the old method of tallying, besides giving the opportunity to make a much more thorough analysis of the figures." Mr. Wines remarks on the striking manner in which the cards become endowed with meaning and attributes, and adds that for the computer, "a card which means nothing to the uninitiated is converted into a pauper or a criminal, whose sin and suffering are as palpable as if the man himself were bodily present in the room."

It will be obvious that the special use of the Hollerith machine for mortality, crime and pauperism figures renders it equally available for other work. It would easily group, classify and sum up, for instance, the multitudinous details of telegraphy, telephony or electric light and power. As a matter of fact, it has for some time past been in use by the Board of Health of New York City. This general utility of that which has given such remarkable proof of its ability in the Eleventh Census was recognized by the Franklin Institute, in conferring on Mr. Hollerith the Elliot Cresson Medal. The Committee on Science and the Arts of the Institute, after seeing the system in operation at Washington, said: "They are of the opinion that it is invaluable wherever large numbers of individual facts are to be summed and tabulated. They consider that the inventor is deserving of the greatest commendation for this useful and novel application of electricity, and strongly recommend that he be granted for his invention the highest award in the gift of the Franklin Institute."

But perhaps the most practical demonstration of the value of the Hollerith system is its adoption by the Governments of Canada and Austria for their respective censuses. This is the solid appreciation that an inventor most enjoys.

XIV.

It might seem that to have invented such a system as has been described, by which a great nation has been counted for the first time by electricity, is glory enough. But Mr. Hollerith, who, by the way, is a Ph. D. of Columbia College, is the patentee of the inventions upon which the Carpenter electric braking system is based, and has now worked out a novel and valuable integrating device which is deserving of description. In the compilation of census statistics, such as those of population, mortality, etc., or the bulk of the work to which the Hollerith apparatus has heretofore been applied, the person forms the unit, so that each card represents simply that unit. But the census includes agricultural, manufacturing and similar statistics, and it is evident that in the figures of agriculture or manufacture, while a card might represent a farm or a factory unit, the *value* of that unit might vary greatly. Thus it might be a farm of a hundred acres or of five hundred, and we would thus have to record *amounts*. This can be readily done by such a machine as that here shown in Fig. 15. The cards could be punched, as already described,

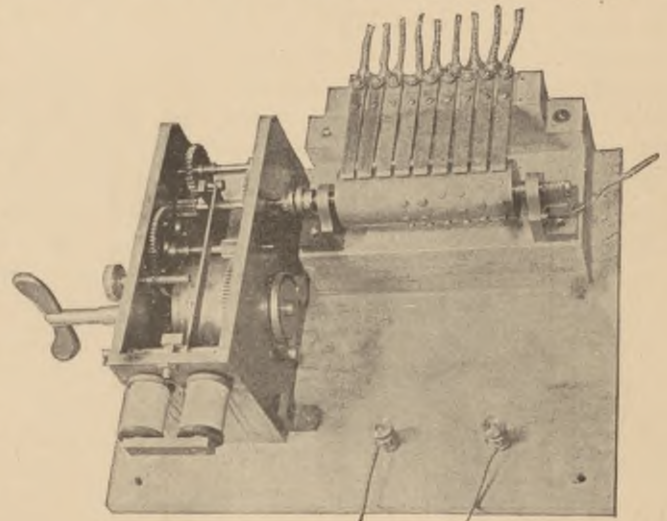

FIG. 15.—HOLLERITH INTEGRATING MACHINE.

but when they entered the tabulating machine, a dial would be energized and would operate not merely once, as in the ordinary population statistics, but would count from one to nine, according to the value of the hole, the counting being determined, as before, by the location of the hole. The device consists, broadly, in a cylinder around whose circumference studs are set; spring contact points connected to the mercury cups of the press; a motor for revolving the cylinder in conjunction with a train of ordinary registering mechanism, and a device for starting the motor so that the cylinder will make one revolution. The operation can be readily understood. A card being put in the press, the circuit is closed through a given counter to the battery, to the cylinder of the integrating device, from one of the nine contact strips of the integrator through the corresponding mercury cup uncovered by the punched hole of the card through the plunger of the pin box corresponding to that hole, and back to the counter. At the same time another circuit is closed through the magnet, when the handle is brought down, which allows the train to revolve the cylinder of the integrating device one revolution. During that revolution the circuit through the dial counter will be made and broken from one to nine times, according to the contact strip which is brought into operation. Any number of counters can thus be operated at the same time, they being connected in multiple arc. The registration thus secured gives totals from any number of different sizes or amounts, and the device, therefore, answers a most useful purpose.

xv.

Not a little skill and judgment was necessary in perfecting the mechanical details of the Hollerith electric tabulating system that has been described above, and Mr. Hollerith freely acknowledges his indebtedness for the assistance of the manufacturers who built his apparatus. To the Pratt & Whitney Co., of Hartford, Connecticut, he wisely entrusted the development and construction of the keyboard punches, and Mr. George M. Bond, the well-known expert of the concern, gave the work his direct personal supervision from first to last. The electrical apparatus is the production of the Western Electric Co., whose New York representatives, Mr. H. B. Thayer and Mr.

Nickel, as well as others, took a deep interest in its refinement and perfection. Of course the work itself, which will continue at the Census Office for some time yet, is watched over by Mr. Hollerith, who is under contract to the Government to furnish the apparatus and maintain it in an efficient state. It may be added that the current for doing the work is derived from the local Edison lighting circuits in Washington, being first passed through a small set of Electrical Accumulator Co.'s cells grouped in a corner of the basement, with the usual attachments for charging in series and regrouping in multiple, as well as for making tests to see that they are up to the requirements of the daily work.

[EDITORIAL.]

CENSUS-TAKING BY ELECTRICITY.

OUR pages contain this week a description of the manner in which the Census of 1890 has been counted by the ingenious Hollerith electric tabulating machine. None but they who have seen the apparatus can realize the ease and accuracy with which it performs its task, dealing with the utmost facility with the most complicated combinations of statistical data. It will be remembered that in various quarters no little fault has been found with the census taken under the supervision of Mr. Porter. Possibly these criticisms may be well based so far as the selection of the local enumerators is concerned, and possibly all these enumerators did not perform their duty as well as might have been wished, but when it comes to the counting inside the Census Office, all we have to say is that we do not believe it could be better done than in the manner devised by Mr. Herman Hollerith. And this is said with the more emphasis because some of the bitter articles in the daily papers have been enough to lead one to think that, after all, the political bias shown in them might be justified by shortcomings in the methods adopted and in the failure of electricity to execute the great task laid upon it. So far from proving inadequate, the Hollerith system has more than fulfilled its promise, and in one important de-

partment alone effected a saving of 40 per cent. above the estimate of the expert commission that recommended its adoption.

Now that census authorities have had such admirable apparatus placed at their disposal, it is to be hoped that a permanent Census Bureau may be established, and a permanent staff be formed. The necessity of such a bureau is seen when men like Gen. Walker and Col. Carroll D. Wright join hands with Mr. Porter in efforts to secure it. It is painful to reflect that, in spite of the money and pains spent on the Census of 1880, the elementary information obtained by it as to the number of married and single people has never been elicited! Electrical people have lately had an experience of this kind in the starting out to secure electrical data and then the proposal to let the work drop to the ground because time and money were wanting. It seems to us that it would be nothing more than fair if part of the money saved by the Hollerith electric tabulating system were devoted to the perfection of the electrical census, giving us for the first time in history trustworthy figures as to the industry; and that the remainder were spent in founding a permanent bureau which shall give every industry and society at large, at all times, the data and statistics which, if rightly collected and interpreted, must be at the basis of all successful work and all intelligent advance.

